

# 1978 KZ650-B2 PARTS DIAGRAM

## SWING ARM/SHOCK ABSORBERS

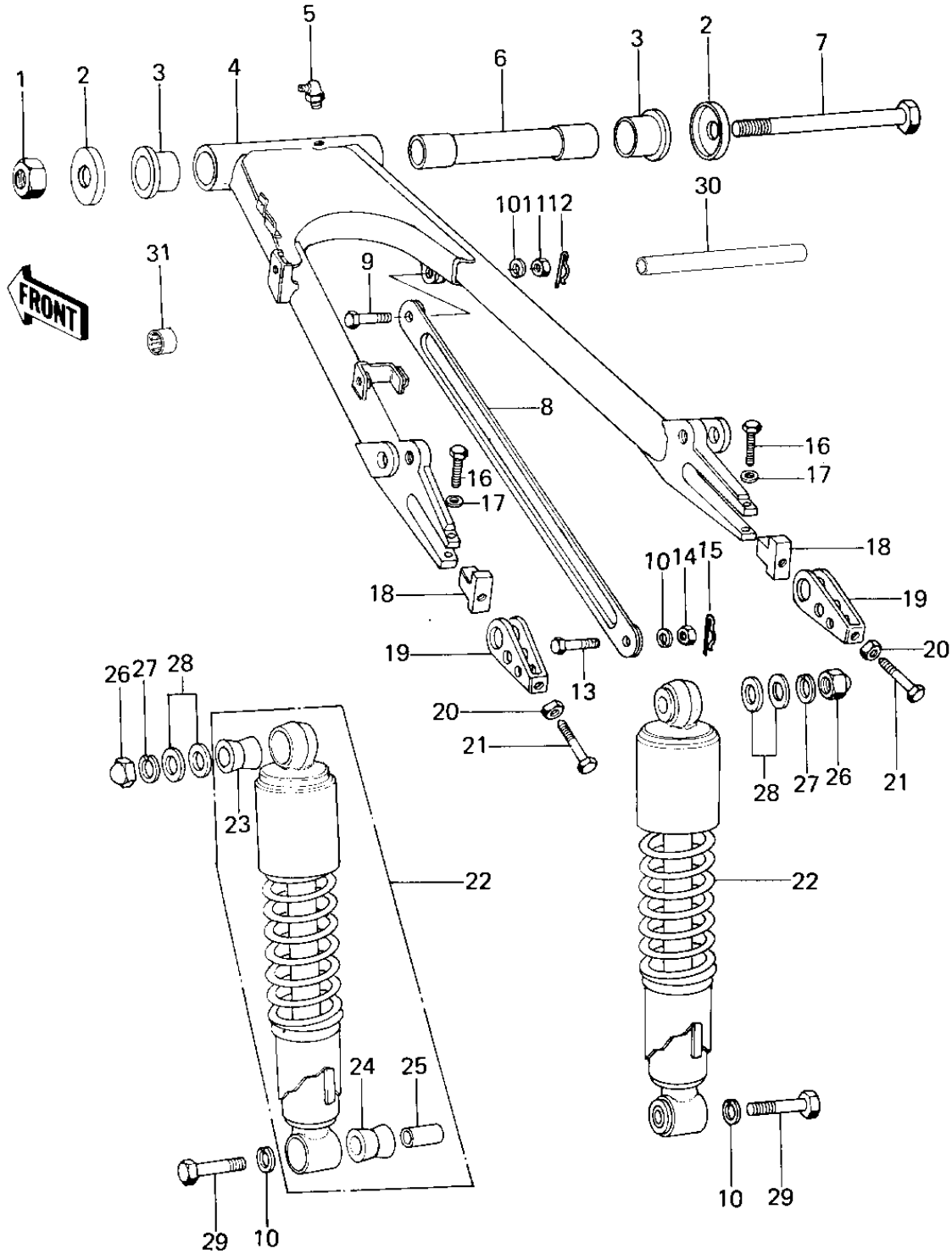

# 1978 KZ650-B2 PARTS LIST

## SWING ARM/SHOCK ABSORBERS

ITEM NAME	PART NUMBER	QUANTITY
NUT-SELF LOCKING (Ref # 1)	92019-012	1
CAP,SWING ARM (Ref # 2)	33035-008	1
CAP,SWING ARM (Ref # 2)	33035-009	1
BUSHING-SWING ARM (Ref # 3)	33033-009	1
SWING ARM (Ref # 4)	33001-089	1
ARM-COMP-SWING (Ref # 4)	33001-1078	1
GREASE NIPPLE (Ref # 5)	92005-002	1
SLEEVE,SWING ARM (Ref # 6)	33034-024	1
SHAFT,SWING ARM (Ref # 7)	33032-050	1
TORQUE LINK-REAR BRK (Ref # 8)	43007-027	1
BOLT (Ref # 9)	92003-096	1
WASHER SPRING 10MM (Ref # 10)	461F1000	1
NUT,10MM (Ref # 11)	314B1000	1
PIN,SNAP (Ref # 12)	554A0800	1
BOLT HEX HEAD 10MM (Ref # 13)	92003-034	1
NUT 10MM (Ref # 14)	315B1000	1
PIN,SNAP (Ref # 15)	554A0800	1
BOLT,FLANGED,8X35 (Ref # 16)	92001-1577	1
WASHER SPRING 8MM (Ref # 17)	461F0800	1
STOPPER,CHAIN ADJUST (Ref # 18)	33044-002	1
ADJUSTER,CHAIN (Ref # 19)	33040-056	1
NUT 8MM (Ref # 20)	312B0800	1
BOLT,8X50 (Ref # 21)	92001-1399	1
SHOCK ABSBR RR (Ref # 22)	45014-117	1
BUSHING,SHCK ABS RUB (Ref # 23)	45017-015	1
BUSHING,SHOCK ABSORB (Ref # 24)	45016-008	1
BUSHING, SHCK ABS RUB (Ref # 25)	45017-012	1
NUT 12MM (Ref # 26)	92020-014	1
WASHER SPRING 12MM (Ref # 27)	461F1200	1

# 1978 KZ650-B2 PARTS LIST

## SWING ARM/SHOCK ABSORBERS

ITEM NAME	PART NUMBER	QUANTITY
WASHER PLAIN 12MM (Ref # 28)	410B1200	1
BOLT HEX HEAD 10X35 (Ref # 29)	113N1035	1
SLEEVE,SWING ARM (Ref # 30)	42036-1012	1
BEARING-NEEDLE,HK2216 (Ref # 31)	92046-1115	1