

1982 GPz PARTS DIAGRAM

CYLINDER/PISTONS

E1120-0006

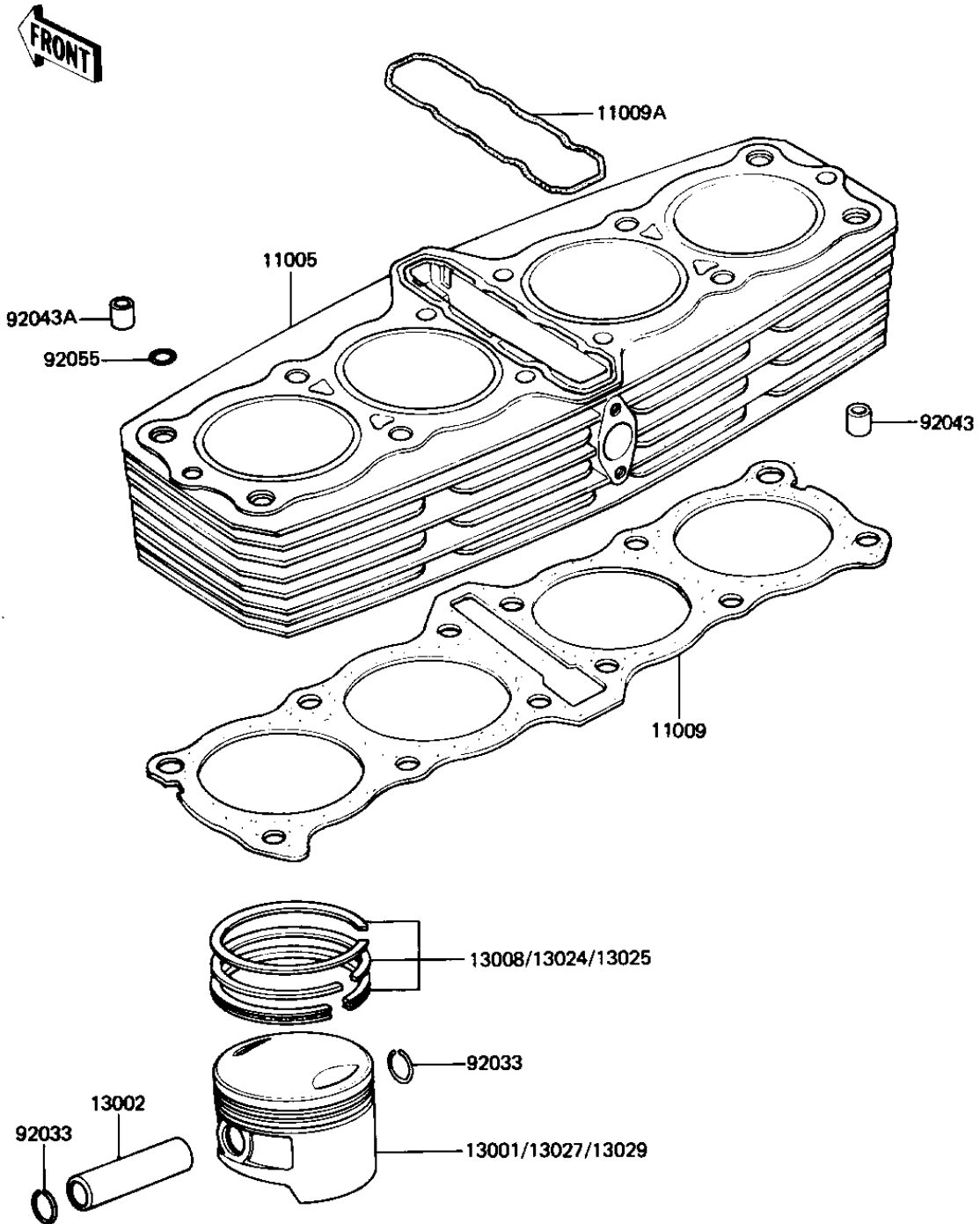

1982 GPz PARTS LIST

CYLINDER/PISTONS

ITEM NAME	PART NUMBER	QUANTITY
CYLINDER-ENGINE,BLACK (Ref # 11005)	11005-1325	1
GASKET,CYLINDER BASE (Ref # 11009)	11060-1067	1
GASKET,CYLINDER (Ref # 11009A)	11009-1208	1
PISTON-ENGINE,STD (Ref # 13001)	13001-1118	4
PIN-PISTON (Ref # 13002)	13002-1013	4
RING-SET-PISTON,STD (Ref # 13008)	13008-5037	4
RING-SET PISTON LL (Ref # 13024)	13024-5023	4
RING-SET PISTON L,O/S (Ref # 13025)	13025-5019	4
PISTON-ENGINE LL,O/S (Ref # 13027)	13027-1055	4
PISTON-ENGINE L,O/S (Ref # 13029)	13029-1057	4
RING-SNAP (Ref # 92033)	92033-1054	8
PIN,11X14X12.3 (Ref # 92043)	92043-1266	2
PIN,DOWEL,10X8.2X14 (Ref # 92043A)	92043-1037	2
RING-0,0D=18.5MM (Ref # 92055)	92055-1148	4