

1976 KZ750-B1 PARTS DIAGRAM

SWING ARM/SHOCK ABSORBERS

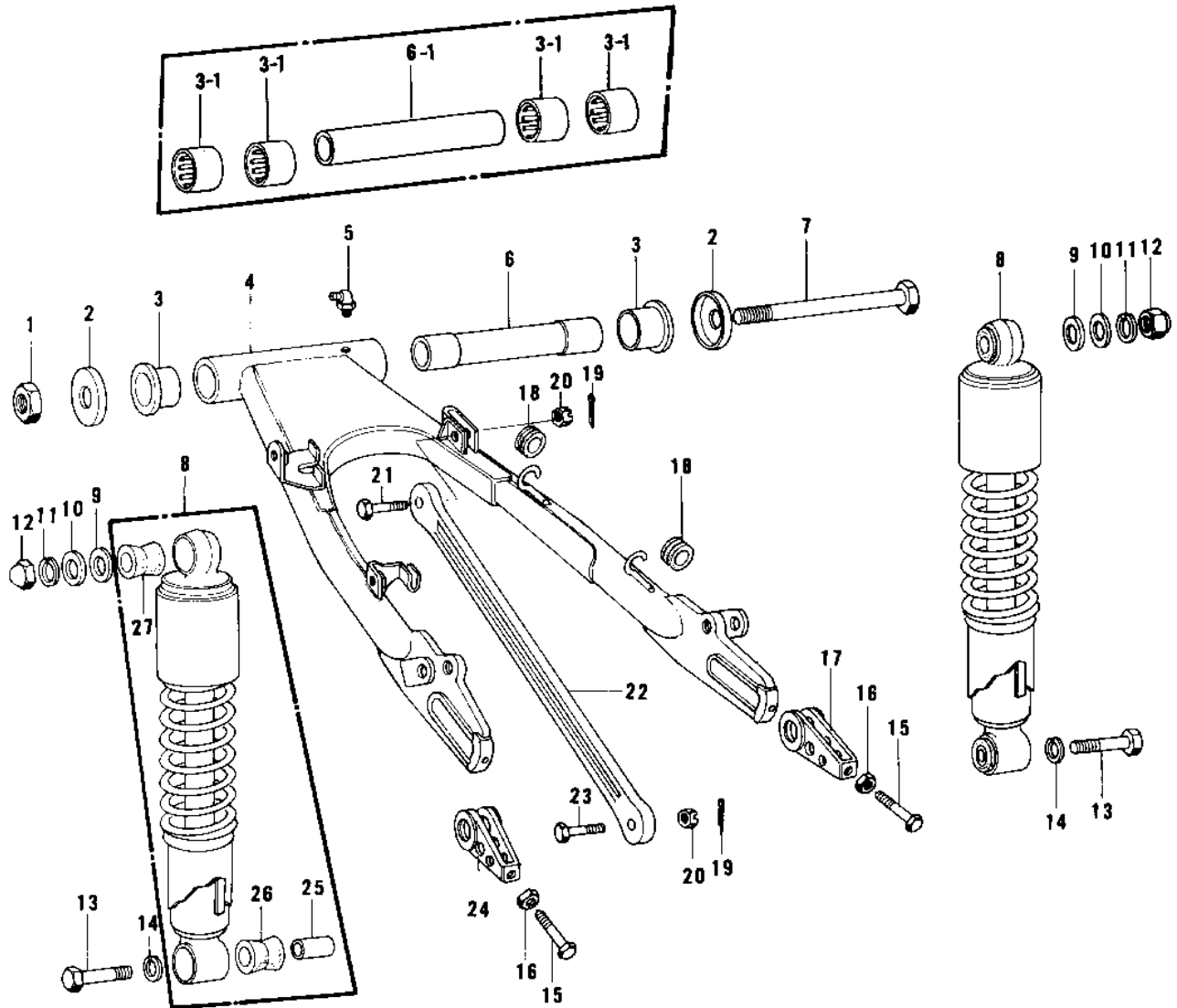

1976 KZ750-B1 PARTS LIST

SWING ARM/SHOCK ABSORBERS

ITEM NAME	PART NUMBER	QUANTITY
NUT-SELF LOCKING (Ref # 1)	92019-012	1
CAP,SWING ARM (Ref # 2)	33035-008	2
CAP,SWING ARM (Ref # 2)	33035-009	2
BUSHING-SWING ARM (Ref # 3)	33033-009	2
BEARING-NEEDLE,HK2216 (Ref # 3-1)	92046-1115	4
ARM,SWING (Ref # 4)	33001-1004	1
ARM,SWING (Ref # 4)	33001-1012	1
GREASE NIPPLE (Ref # 5)	92005-002	1
SLEEVE,SWING ARM (Ref # 6)	33034-022	1
SLEEVE,SWING ARM (Ref # 6-1)	42036-1014	1
SHAFT,SWING ARM PIVOT (Ref # 7)	33032-047	1
SHOCK ABSBR RR (Ref # 8)	45014-105	2
WASHER-PL-10.5X26X2.3 (Ref # 9)	92022-044	2
WASHER-PLN,10X22X3.2 (Ref # 9)	92022-176	2
WASHER PLAIN 10MM (Ref # 10)	411B1000	2
WASHER SPRING 10MM (Ref # 11)	461F1000	2
NUT SHOCK ABSORBER (Ref # 12)	92020-003	2
BOLT HEX HEAD 10X35 (Ref # 13)	113N1035	2
WASHER SPRING 10MM (Ref # 14)	461F1000	2
BOLT,CHAIN ADJUST (Ref # 15)	92001-162	2
NUT 10MM (Ref # 16)	315B1000	2
ADJUSTER,R.H (Ref # 17)	33040-069	1
DAMPER RUBBER (Ref # 18)	43064-007	2
PIN COTTER 3.0X25 (Ref # 19)	550D3025	2
NUT,12MM (Ref # 20)	42045-021	2
BOLT,FR TORQUE LINK (Ref # 21)	92003-196	1
TORQUE LINK (Ref # 22)	43007-047	1
BOLT,RR TORQUE LINK (Ref # 23)	92003-197	1
ADJUSTER,CHAIN (Ref # 24)	33040-066	1

1976 KZ750-B1 PARTS LIST

SWING ARM/SHOCK ABSORBERS

ITEM NAME	PART NUMBER	QUANTITY
BUSHING, SHCK ABS RUB (Ref # 25)	45017-012	2
BUSHING,SHOCK ABSORB (Ref # 26)	45016-008	2
BUSHING,SHCK ABS RUB (Ref # 27)	45017-015	2