

1979 KZ750-B4 PARTS DIAGRAM

BATTERY CASE/TOOL CASE

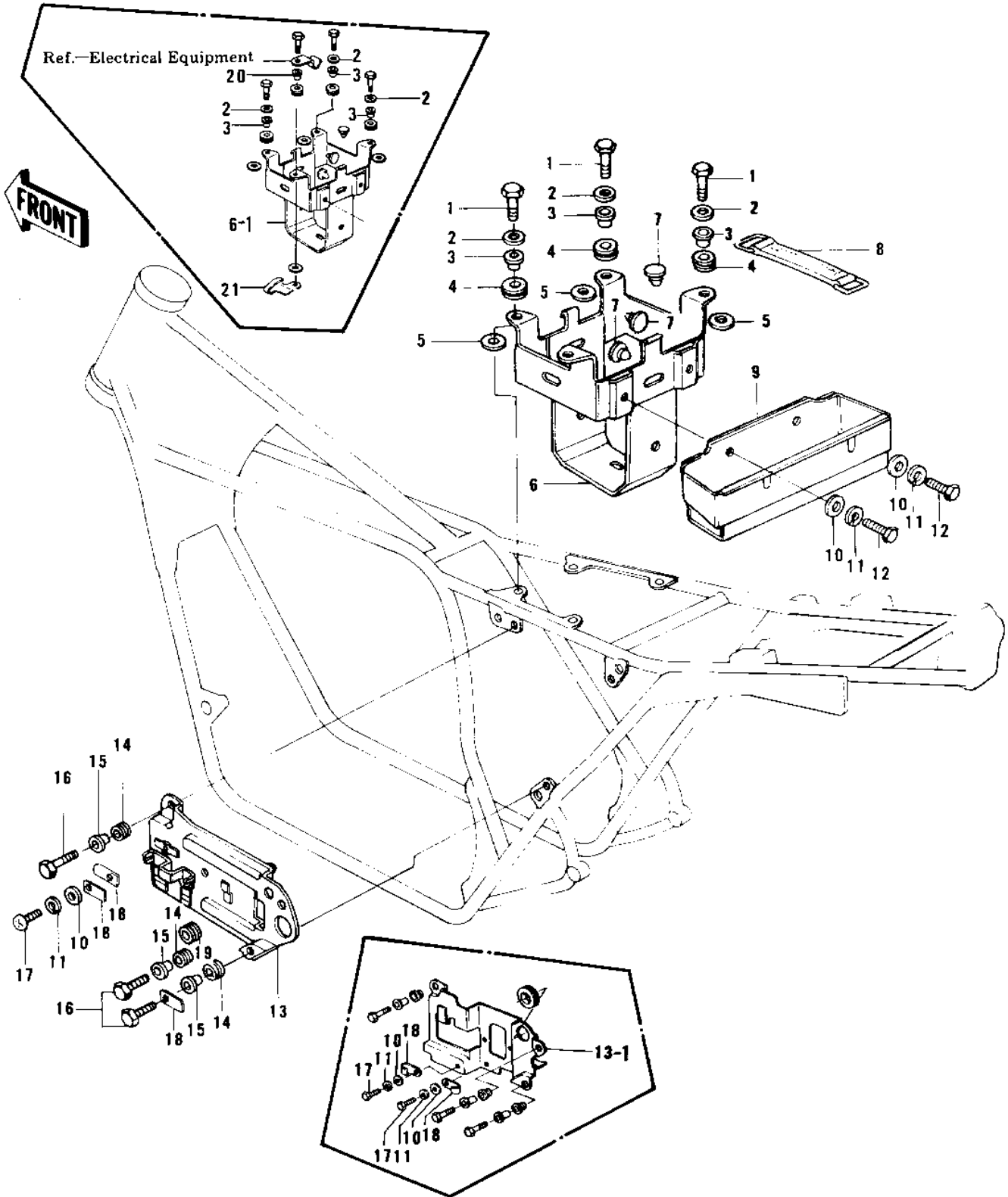

1979 KZ750-B4 PARTS LIST

BATTERY CASE/TOOL CASE

ITEM NAME	PART NUMBER	QUANTITY
BOLT-UPSET (Ref # 1)	112G0625	4
WASHER 6.5X20X1.6T (Ref # 2)	92022-125	4
WASHER 6.5X20X1.6T (Ref # 2)	92022-125	3
COLLAR (Ref # 3)	92027-268	4
COLLAR (Ref # 3)	92027-268	3
DAMPER RUBBER (Ref # 4)	92075-277	4
DAMPER RUBBER (Ref # 5)	92075-166	4
CASE,BATTERY (Ref # 6)	32097-1006	1
CASE,BATTERY (Ref # 6-1)	32097-1006	1
DAMPER RUBBER (Ref # 7)	92075-078	3
BAND,BATTERY (Ref # 8)	92072-071	1
CASE,TOOL (Ref # 9)	32098-026	1
WASHER PLAIN 6MM (Ref # 10)	411B0600	4
WASHER SPRING 6MM (Ref # 11)	461F0600	4
BOLT-UPSET,6X12 (Ref # 12)	112G0612	2
BRACKET (Ref # 13)	32129-005	1
BRACKET,ELECTRO BASE (Ref # 13-1)	11034-1104	1
DAMPER RUBBER (Ref # 14)	92075-277	3
COLLAR (Ref # 15)	92027-194	3
BOLT-UPSET,6X20 (Ref # 16)	112G0620	3
SCREW PAN HEAD 6X12 (Ref # 17)	220B0612	1
BOLT-UPSET,6X12 (Ref # 17)	112G0612	2
CLAMP,HARNESS (Ref # 18)	92037-113	3
GROMMET (Ref # 19)	92071-092	1
COLLAR (Ref # 20)	92027-194	1
HOOK,HELMET (Ref # 21)	27012-1009	1