

# 1972 Mach IV PARTS DIAGRAM

SWING ARM/SHOCK ABSORBERS (H2/A)

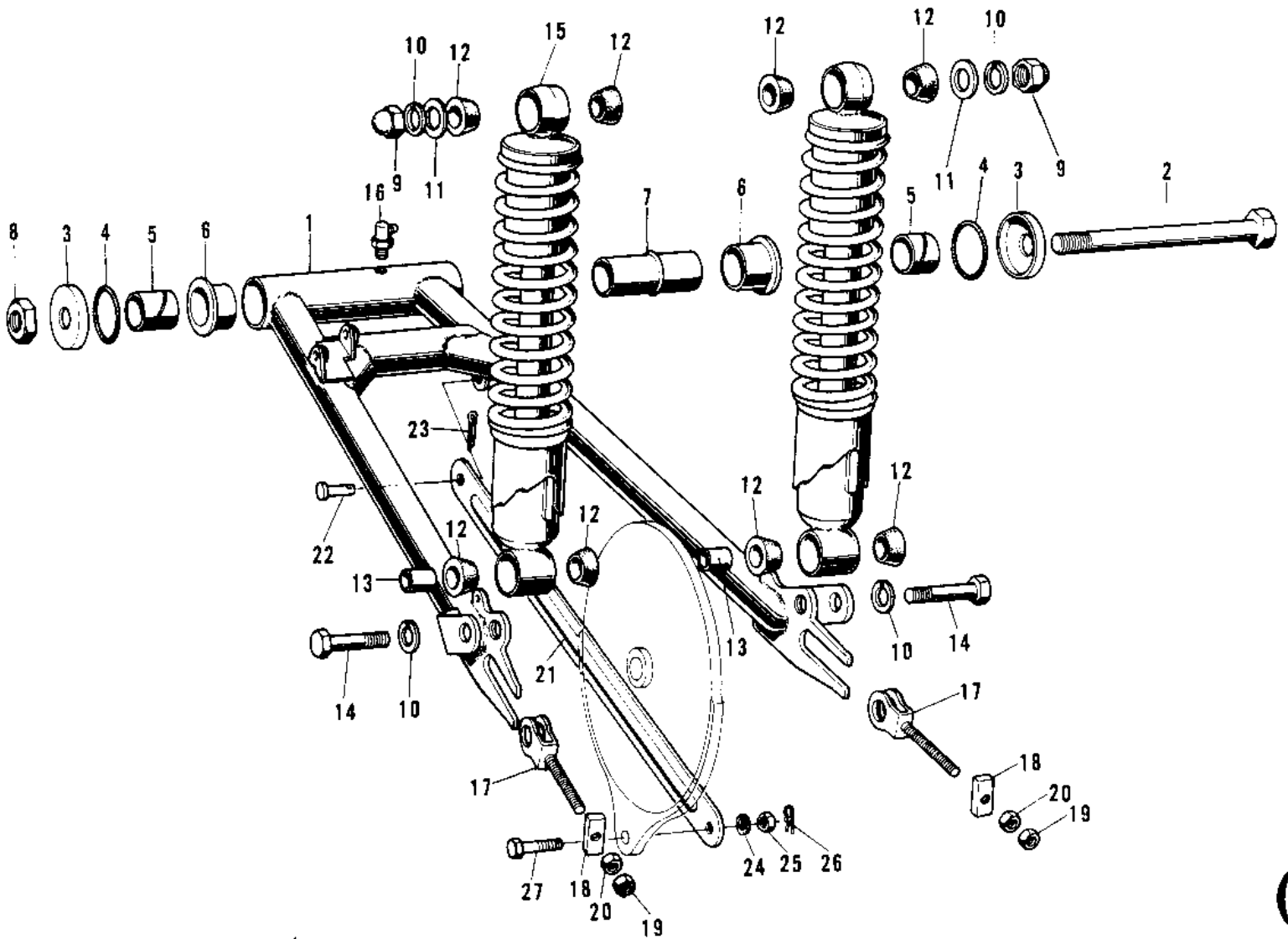

# 1972 Mach IV PARTS LIST

## SWING ARM/SHOCK ABSORBERS (H2/A)

ITEM NAME	PART NUMBER	QUANTITY
ARM-SWING (Ref # 1)	33001-049	1
SHAFT-SWING ARM PIVOT (Ref # 2)	33032-038	1
CAP,SWING ARM (Ref # 3)	33035-007	2
"0" RING,30MM (Ref # 4)	671B2530	2
SLEEVE SWING ARM (Ref # 5)	33034-009	2
BUSHING-SWING ARM (Ref # 6)	33033-009	2
SLEEVE SWING ARM LONG (Ref # 7)	33034-008	1
NUT-SELF LOCKING (Ref # 8)	92019-012	1
NUT SHOCK ABSORBER (Ref # 9)	92020-003	2
WASHER SPRING 10MM (Ref # 10)	461F1000	4
WASHER-PL-10.5X26X2.3 (Ref # 11)	92022-044	2
BUSH SHCK ABS RUBBER (Ref # 12)	45017-001	8
BUSH SHCK ABS PVT SFT (Ref # 13)	45016-003	2
BOLT HEX HEAD 10X35 (Ref # 14)	113N1035	2
SHOCK ABSBR RR (Ref # 15)	45014-061	2
GREASE NIPPLE (Ref # 16)	92005-002	1
ADJUSTER-CHAIN (Ref # 17)	33040-044	2
PLATE-CHAIN ADJUSTER (Ref # 18)	33041-002	2
NUT 8MM (Ref # 19)	312B0800	2
NUT,8MM (Ref # 20)	311B0800	2
TORQUE LINK-REAR BRK (Ref # 21)	43007-027	1
TORQUE LINK-REAR BRK (Ref # 21)	43007-033	1
PIN REAR TORQUE LINK (Ref # 22)	43009-001	1
PIN COTTER 3.0X25 (Ref # 23)	550D3025	1
WASHER SPRING 10MM (Ref # 24)	461F1000	1
NUT 10MM (Ref # 25)	315B1000	1
PIN,SNAP (Ref # 26)	554A0800	1
BOLT-HEX HEAD,10X40 (Ref # 27)	92003-097	1