

1974 Mach IV PARTS DIAGRAM

FRAME/FRAME FITTINGS (H2/A)

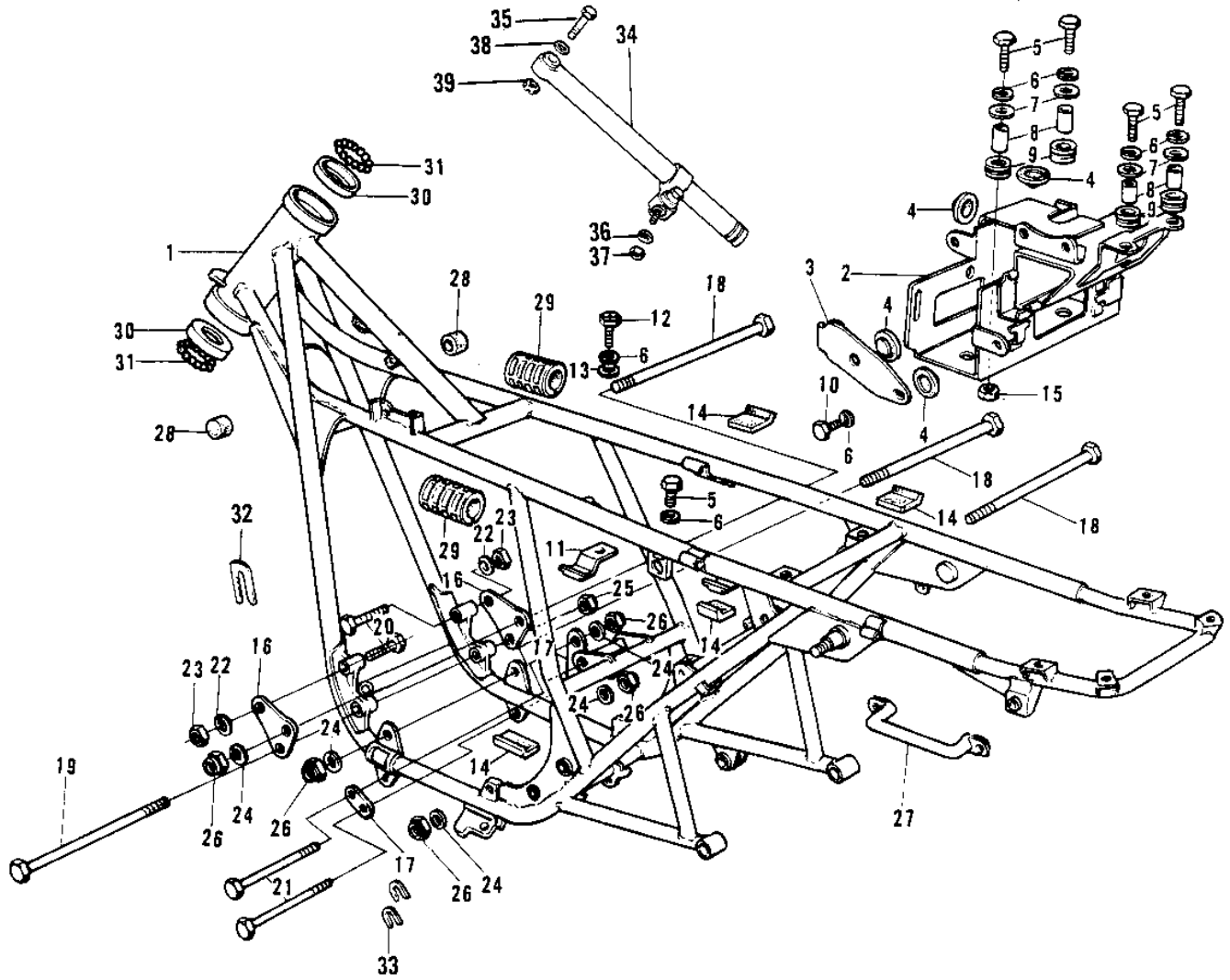

(H2/A)

1974 Mach IV PARTS LIST

FRAME/FRAME FITTINGS (H2/A)

ITEM NAME	PART NUMBER	QUANTITY
FRAME (Ref # 1)	32002-045	
CASE-BATTERY (Ref # 2)	32099-007	
BAND-BATTERY (Ref # 3)	32100-014	
DAMPER RUBBER (Ref # 4)	92075-078	
BOLT-UPSET,6X20 (Ref # 5)	112G0620	
WASHER SPRING 6MM (Ref # 6)	461F0600	
WASHER 6.5X20X1.6T (Ref # 7)	92022-125	
COLLAR,6.8X10X8.5 (Ref # 8)	92027-129	
DAMPER RUBBER (Ref # 9)	92075-076	
BOLT-UPSET 6X14 (Ref # 10)	112B0614	
BRACKET-SIDE COVER (Ref # 11)	32095-010	
BOLT-HEX HEAD,6X16 (Ref # 12)	92001-114	
WASHER PLAIN 6MM (Ref # 13)	411B0600	
PROTECTOR SIDE COVER (Ref # 14)	31082-005	
NUT 6MM (Ref # 15)	311B0600	
PLATE-ENGINE MOUNT (Ref # 16)	32030-021	
PLATE REAR ENG HOLDER (Ref # 17)	32030-016	
BOLT-ENG MOUNT,10X274 (Ref # 18)	92091-024	
BOLT-ENG MOUNT,8X270 (Ref # 19)	92091-021	
BOLT,HEX HEAD,8X45 (Ref # 20)	92001-1219	
BOLT,HEX HEAD,10X125 (Ref # 21)	92001-1248	
WASHER SPRING 8MM (Ref # 22)	461F0800	
NUT,8MM (Ref # 23)	311B0800	
WASHER PLAIN 10MM (Ref # 24)	410B1000	
NUT,LOCK,8MM (Ref # 25)	92015-1124	
NUT,10MM (Ref # 26)	92015-1429	
GRIP-FRAME (Ref # 27)	32109-012	
DAMPER RUBBER (Ref # 28)	92075-044	
DAMPER RUBBER (Ref # 29)	92075-084	

1974 Mach IV PARTS LIST

FRAME/FRAME FITTINGS (H2/A)

ITEM NAME	PART NUMBER	QUANTITY
RACE STRNG STEM BERNG (Ref # 30)	92048-006	
BALL STEEL 1/4' (Ref # 31)	600A0800	
SHIM-ENG FIT FR,0.5MM (Ref # 32)	92025-053	
SHIM-ENG FIT FR,0.8MM (Ref # 32)	92025-054	
SHIM-ENG FIT FR,1.0MM (Ref # 32)	92025-055	
SHIM-ENG FIT FR,1.6MM (Ref # 32)	92025-056	
SHIM-ENG FIT FR,2.0MM (Ref # 32)	92025-057	
SHIM-ENG FIT FR,2.3MM (Ref # 32)	92025-058	
SHIM-ENG FIT RR,0.5MM (Ref # 33)	92025-048	
SHIM-ENG FIT RR,0.8MM (Ref # 33)	92025-049	
SHIM-ENG FIT RR,1.0MM (Ref # 33)	92025-050	
SHIM-ENG FIT RR,1.6MM (Ref # 33)	92025-051	
SHIM-ENG FIT RR,2.0MM (Ref # 33)	92025-052	
OIL DAMPER-STEERING (Ref # 34)	46117-006	
BOLT-SMALL-UPSET,8X30 (Ref # 35)	115G0830	
WASHER SPRING 8MM (Ref # 36)	461F0800	
NUT,LOCK,8MM (Ref # 37)	92015-1124	
WASHER PLAIN 8MM (Ref # 38)	411B0800	
NUT,8MM (Ref # 39)	311B0800	