

1974 Mach IV PARTS DIAGRAM

CYLINDER HEADS/CYLINDERS

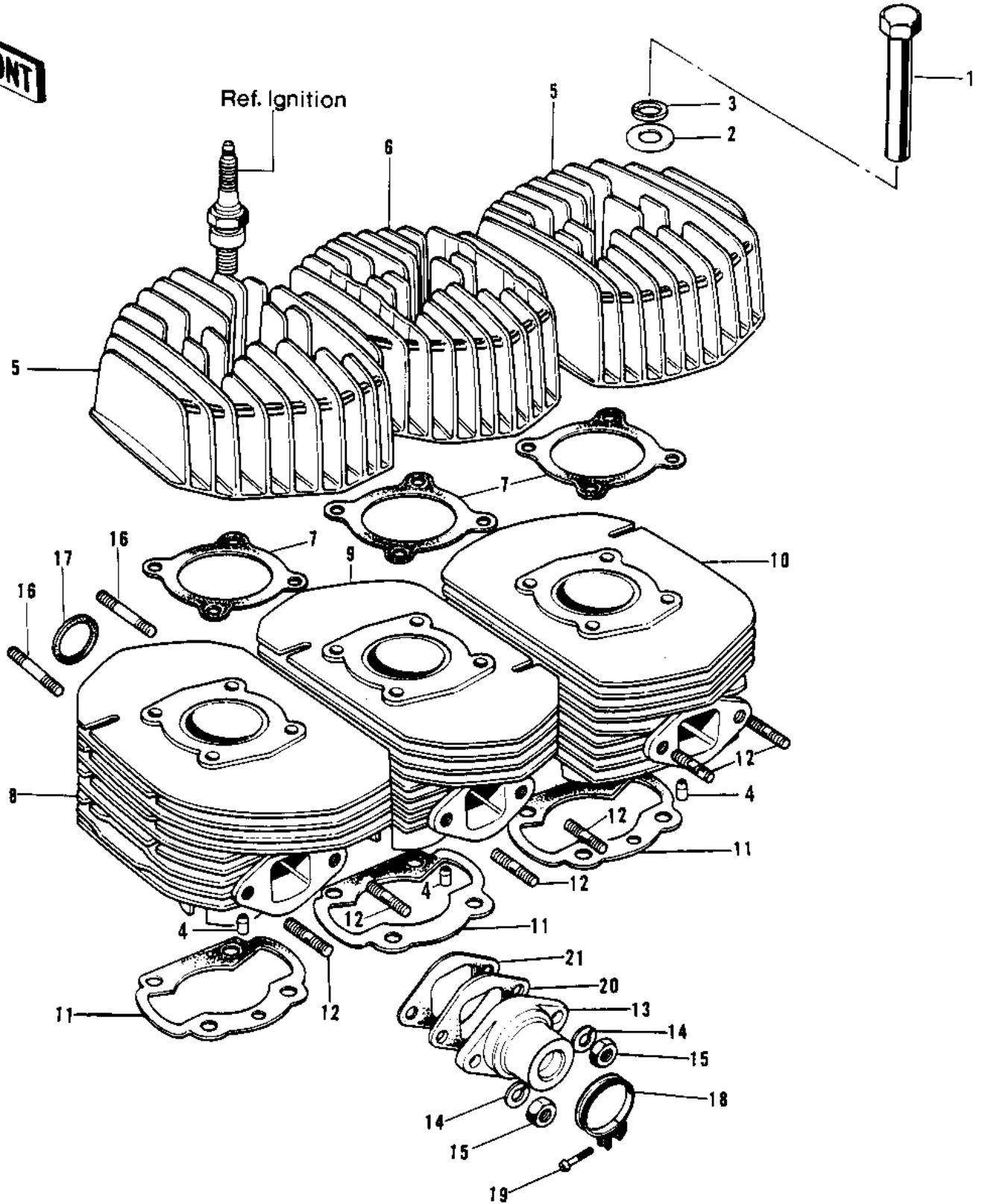

1974 Mach IV PARTS LIST

CYLINDER HEADS/CYLINDERS

ITEM NAME	PART NUMBER	QUANTITY
NUT-CYLINDER HEAD (Ref # 1)	92015-049	
WASHER PLAIN 14MM (Ref # 2)	410B1400	
WASHER SPRING 14MM (Ref # 3)	461F1400	
NOZZLE,OIL METERING (Ref # 4)	92062-008	
CYLINDER HEAD,L.H&R.H (Ref # 5)	11001-066	
CYLINDER HEAD,R.H&L.H (Ref # 5)	11001-096-2H	
CYLINDER HEAD,CENTER (Ref # 6)	11001-067	
CYLINDER HEAD,CENTER (Ref # 6)	11001-097-2H	
GASKET-CYLINDER HEAD (Ref # 7)	11004-049	
CYLINDER,L.H (Ref # 8)	11005-109	
CYLINDER,L.H BARREL (Ref # 8)	11005-128-2H	
CYLINDER,CENTER (Ref # 9)	11005-110	
CYLINDER,CENTER BAREL (Ref # 9)	11005-129-2H	
CYLINDER,R.H (Ref # 10)	11005-111	
CYLINDER,R.H BARREL (Ref # 10)	11005-130-2H	
GASKET-CYLINDER BASE (Ref # 11)	11009-028	
STUD,8X16 (Ref # 12)	172G0816	
INLET-AIR (Ref # 13)	16060-013	
WASHER SPRING 8MM (Ref # 14)	461F0800	
NUT,8MM (Ref # 15)	311B0800	
STUD,8X25 (Ref # 16)	92004-1008	
GASKET EXHAUST PIPE (Ref # 17)	18067-008	
CLAMP-INLET PIPE (Ref # 18)	92037-061	
SCREW-PAN-CROS (Ref # 19)	220B0535	
INSULATOR-HEAT (Ref # 20)	16061-014	
GASKET-AIR INLET (Ref # 21)	16062-016	