

1969 Commander PARTS DIAGRAM

TRANSMISSION (E/NO. W2M 001-)

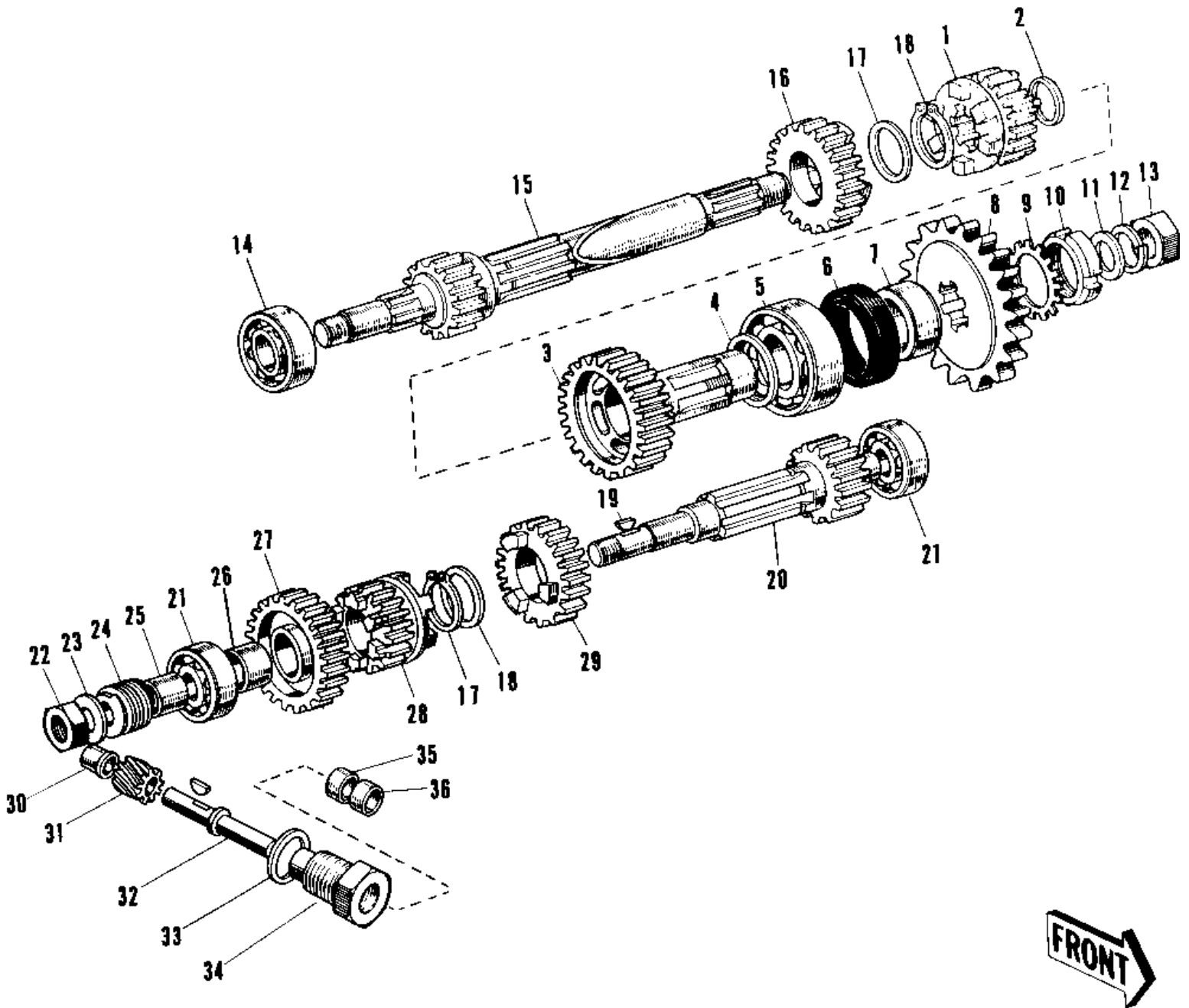

1969 Commander PARTS LIST

TRANSMISSION (E/NO. W2M 001-)

ITEM NAME	PART NUMBER	QUANTITY
2ND GEAR DRIVE SHAFT (Ref # 1)	13130-012	1
WASHER TOP GEAR THRST (Ref # 2)	92026-041	1
TOP GEAR DRIVE SHAFT (Ref # 3)	13136-018	1
SPACER TOP GEAR (Ref # 4)	92026-039	1
BEARING BALL #6206N (Ref # 5)	92045-006	1
OIL SEAL SC405465 (Ref # 6)	92050-018	1
SPACER ENG SPROCKET (Ref # 7)	92027-042	1
ENGINE SPROCKET 19T (Ref # 8)	13144-021	1
WASHER LOCK 30MM (Ref # 9)	92032-001	1
NUT 30MM (Ref # 10)	92015-011	1
WASHER MAIN SHT THRST (Ref # 11)	92026-040	1
WASHER SPRING 16MM (Ref # 12)	461E1600	1
NUT 16MM (Ref # 13)	92015-029	1
BEARING BALL #6204 (Ref # 14)	601A6204	1
SHAFT DRIVE (Ref # 15)	13127-015	1
UNAVAILABLE IN PRICE BOOK (Ref # 16)	13132-010	1
WASHER 28MM (Ref # 17)	92022-103	1
CIRCLIP 28MM (Ref # 18)	480J2800	1
WOODRUFF KEY SPD GEAR (Ref # 19)	92038-006	1
SHAFT OUTPUT (Ref # 20)	13128-016	1
BEARING BALL #6302 (Ref # 21)	601B6302	1
NUT 14MM (Ref # 22)	315B1400	1
WASHER SPRING 14MM (Ref # 23)	461F1400	1
UNAVAILABLE IN PRICE BOOK (Ref # 24)	13224-002	1
SPACER SPEED PINION (Ref # 25)	92027-043	1
WASHER MAIN SHT THRST (Ref # 26)	92026-017	1
LOW GEAR OUTPUT SHAFT (Ref # 27)	13129-020	1
3RD GEAR OUTPUT SHAFT (Ref # 28)	13133-010	1
2ND GEAR OUTPUT SHAFT (Ref # 29)	13131-014	1

1969 Commander PARTS LIST

TRANSMISSION (E/NO. W2M 001-)

ITEM NAME	PART NUMBER	QUANTITY
BUSH SPEED GEAR SHAFT (Ref # 30)	92028-084	1
GEAR SPEEDOMETER (Ref # 31)	13225-001	1
SHAFT SPEED GEAR (Ref # 32)	13226-001	1
GASKET SPD GR HOUSING (Ref # 33)	92065-032	1
HOUSING SPEED GEAR (Ref # 34)	13227-001	1
OIL SEAL VB8178 (Ref # 35)	92053-005	1
SPACER SPEED GEAR SHT (Ref # 36)	92027-044	1