

1979 SR PARTS DIAGRAM

FOOTRESTS/STANDS

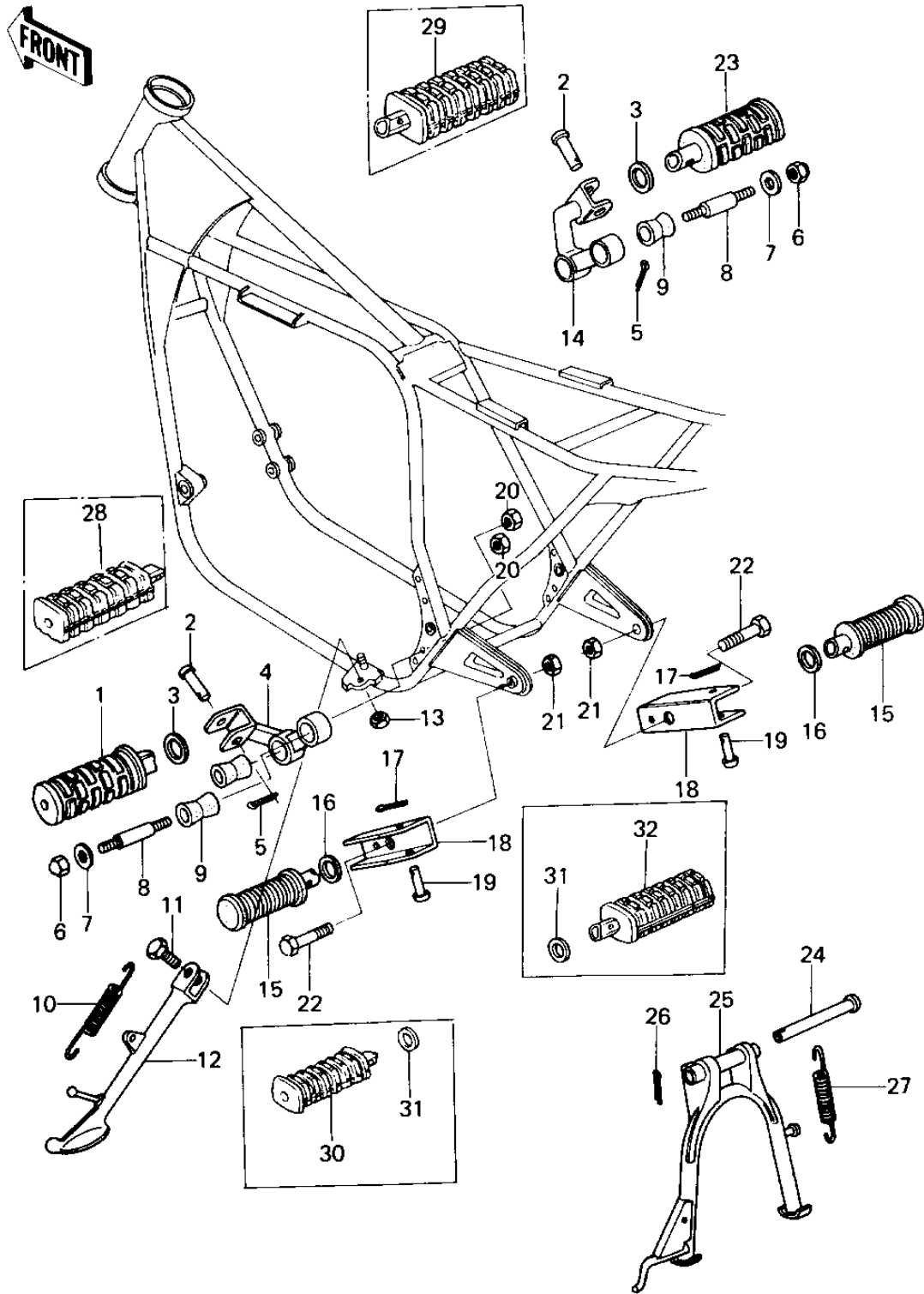

1979 SR PARTS LIST

FOOTRESTS/STANDS

ITEM NAME	PART NUMBER	QUANTITY
BAR-FOOTREST,L.H (Ref # 1)	34028-011	1
PIN-FOOTREST BAR FIT (Ref # 2)	92043-080	1
WASHER,PLAIN (Ref # 3)	92022-250	1
HOLDER,STEP,L.H. (Ref # 4)	34003-1012	1
PIN COTTER 2.5X16 (Ref # 5)	550D2516	1
NUT,CAP AND LOCK,8MM (Ref # 6)	92019-013	1
CAP,FOOTRESTBAR (Ref # 7)	92102-010	1
STUD,FOOTREST BAR FIT (Ref # 8)	92004-048	1
DAMPER RUBBER,FOOTRES (Ref # 9)	92075-293	1
SPRING,SIDE STAND (Ref # 10)	34025-005	1
BOLT-SIDE STAND (Ref # 11)	92003-079	1
STAND-SIDE (Ref # 12)	34024-1103	1
NUT,10MM (Ref # 13)	314B1000	1
HOLDER,STEP,R.H. (Ref # 14)	34003-1015	1
RUBBER,FOOTREST (Ref # 15)	92076-027	1
WASHER-PLAIN (OPT) (Ref # 16)	92022-199	1
PIN,COTTER,2.0X12 (Ref # 17)	550D2012	1
BRACKET,REAR FOOTREST (Ref # 18)	34036-002	1
PIN (Ref # 19)	92043-1464	1
NUT 10MM (Ref # 20)	315B1000	1
NUT,LOCK,10MM (Ref # 21)	92019-021	1
BOLT,HEX HEAD,10X40 (Ref # 22)	92003-213	1
BAR-FOOTREST,R.H (Ref # 23)	34028-012	1
SHAFT,MAIN STAND (Ref # 24)	34019-015	1
STAND-MAIN (Ref # 25)	34011-1003	1
PIN COTTER 3.0X30 (Ref # 26)	550D3030	1
SPRING,MAIN STAND (Ref # 27)	34023-016	1
STEP,FOOTREST,FRONT,L (Ref # 28)	34028-1007	1
STEP,FOOTREST,FRONT,R (Ref # 29)	34028-1008	1

1979 SR PARTS LIST

FOOTRESTS/STANDS

ITEM NAME	PART NUMBER	QUANTITY
STEP,FOOTREST,REAR,LH (Ref # 30)	34028-1009	1
WASHER-PLAIN (Ref # 31)	92022-181	1
STEP,FOOTREST,REAR,RH (Ref # 32)	34028-1010	1