

1979 SR PARTS DIAGRAM

GENERATOR/STARTER MOTOR

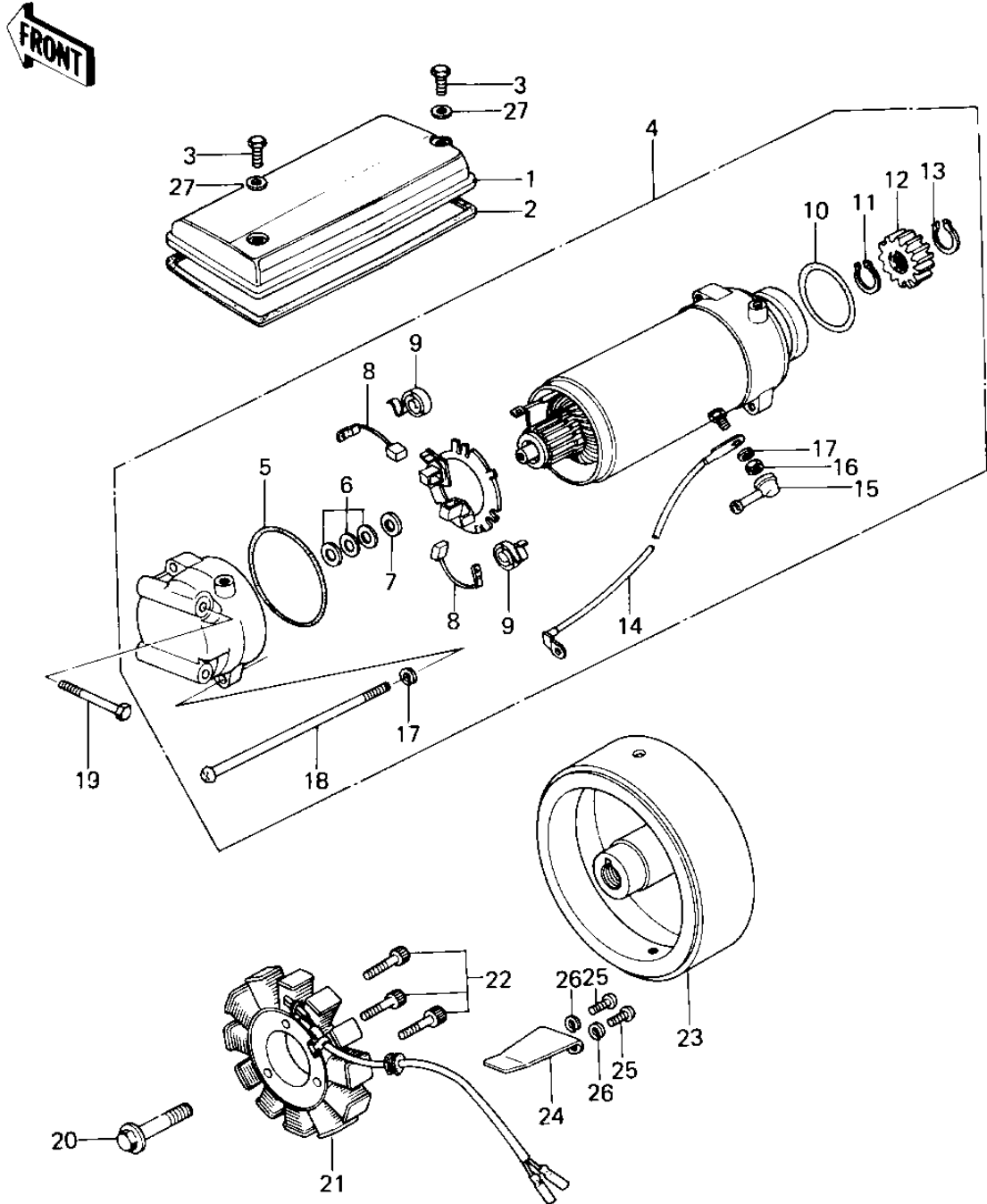

1979 SR PARTS LIST

GENERATOR/STARTER MOTOR

ITEM NAME	PART NUMBER	QUANTITY
COVER,STARTER (Ref # 1)	21165-003	1
GASKET,STARTER COVER (Ref # 2)	21166-003	1
BOLT (6X10) (Ref # 3)	110R0610	1
STARTER-ELECTRIC (Ref # 4)	21163-1022	1
"O" RING,62MM (Ref # 5)	21027-006	1
WASHER,THRUST,0.2T (Ref # 6)	21025-011	1
WASHER,THRUST,1.6T (Ref # 7)	21025-010	1
CARBON BRUSH (Ref # 8)	21039-003	1
SPRING,CARBON BRUSH (Ref # 9)	21040-003	1
"O" RING,40M/M (Ref # 10)	21027-008	1
CIRCLIP (Ref # 11)	92033-034	1
PINION,STARTER (Ref # 12)	21053-004	1
CIRCLIP,13M/M (Ref # 13)	92033-037	1
WIRE-LEAD,STARTER (Ref # 14)	26011-1099	1
CAP,STARTING MOTOR (Ref # 15)	21017-020	1
NUT 6MM (Ref # 16)	312B0600	1
WASHER SPRING 6MM (Ref # 17)	461F0600	1
SCREW,PAN HEAD,6X130 (Ref # 18)	21099-006	1
BOLT-UPSET (Ref # 19)	112G0660	1
BOLT,10X40 (Ref # 20)	92001-1201	1
STATOR (Ref # 21)	21003-1005	1
BOLT-SOCKET,5X30 (Ref # 22)	120P0530	1
FLYWHEEL (Ref # 23)	21050-1003	1
CLAMP,GENERATOR WIRE (Ref # 24)	92037-1122	1
SCREW PAN HEAD 5X12 (Ref # 25)	220B0512	1
WASHER SPRING 5MM (Ref # 26)	461F0500	1
WASHER,PLAIN,6MM (Ref # 27)	410D0600	1