

1976 KZ400-D3 PARTS DIAGRAM

OIL PUMP/OIL FILTER ('76 -'77 KZ400 - D3)

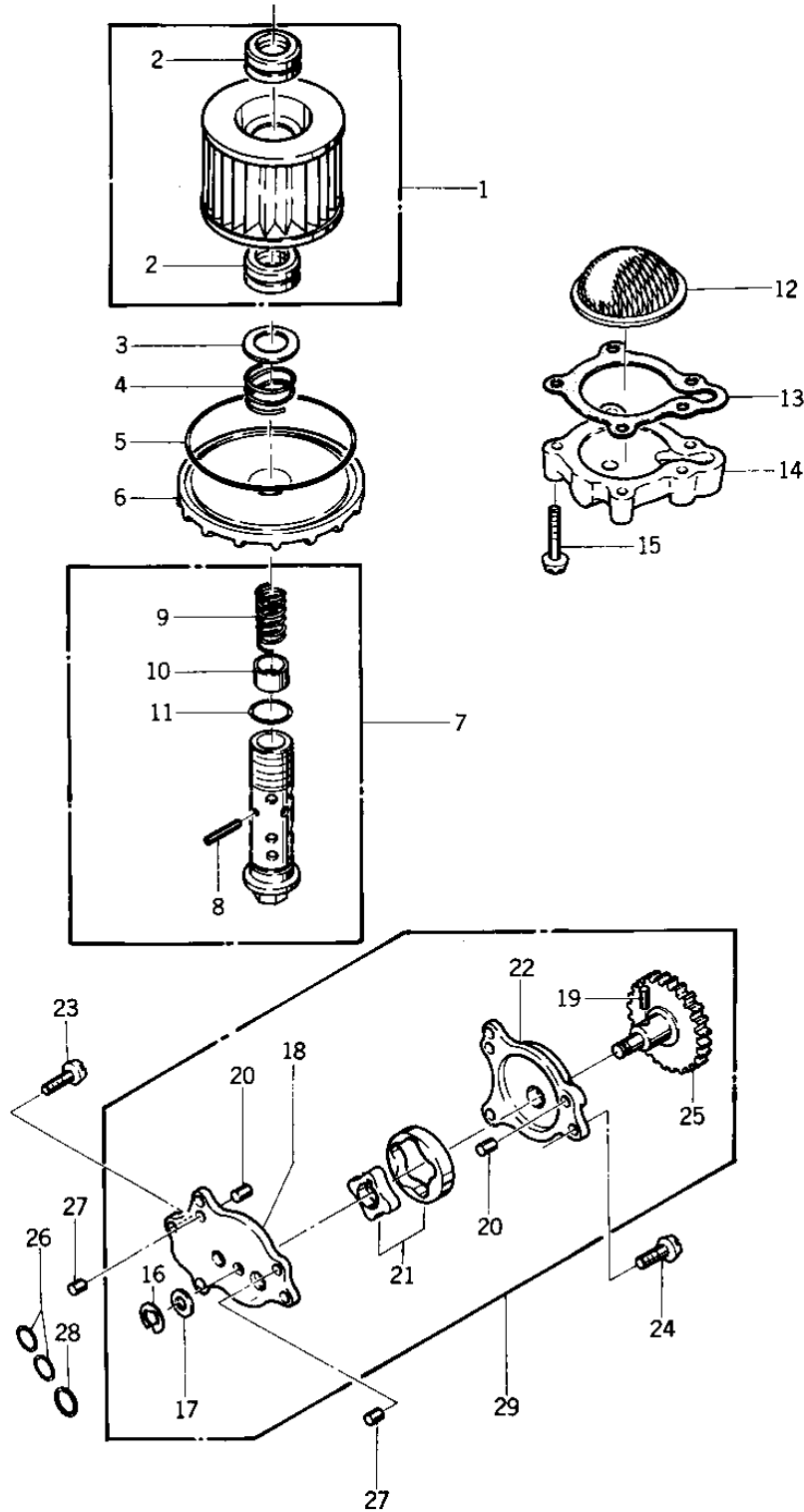

1976 KZ400-D3 PARTS LIST

OIL PUMP/OIL FILTER ('76 -'77 KZ400 - D3)

ITEM NAME	PART NUMBER	QUANTITY
FILTER,OIL (Ref # 1)	16099-003	1
GROMMET,OIL FILTER (Ref # 2)	16135-010	1
SHIM-KICK SHAFT (Ref # 3)	92022-144	1
SPRING,OIL FILTER (Ref # 4)	92081-1018	1
SPRING,OIL FILTER (Ref # 4)	92081-1018	1
"O" RING,90MM (Ref # 5)	671B2590	1
COVER,OIL FILTER (Ref # 6)	16101-004	1
VALVE,OIL FILTER (Ref # 7)	16126-1108	1
VALVE,OIL FILTER (Ref # 7)	16126-1108	1
SPRING PIN (Ref # 8)	92043-111	1
SPRING,PISTON (Ref # 9)	92081-133	1
PISTON (Ref # 10)	92136-001	1
"O" RING,16MM (Ref # 11)	670B2016	1
STRAINER,OIL (Ref # 12)	16111-003	1
GASKET,OIL FILTER COV (Ref # 13)	11009-1874	1
COVER,OIL STRAINER (Ref # 14)	16101-003	1
SCREW PAN HEAD 6X30 (Ref # 15)	220B0630	5
CIRCLIP 5MM (Ref # 16)	482K5000	1
WASHER,THRUST (Ref # 17)	92026-098	1
COVER,OIL PUMP (Ref # 18)	16142-002	1
PIN,DOWEL,4X8 (Ref # 19)	551A0408	1
PIN,DOWEL,6X8 (Ref # 20)	551A0608	2
ROTOR ASSY,OIL PUMP (Ref # 21)	16154-001	1
BODY,OIL PUMP (Ref # 22)	16141-002	1
SCREW PAN HEAD 6X18 (Ref # 23)	220B0618	1
SCREW PAN HEAD 6X25 (Ref # 24)	220B0625	3
GEAR,OIL PUMP DRIVEN (Ref # 25)	16085-023	1
"O" RING,11.5MM (Ref # 26)	92055-072	2
PIN,DOWEL,6X8 (Ref # 27)	551A0608	2