

1977 KH400-A4 PARTS DIAGRAM

KICKSTARTER MECHANISM ('76-'78 A3/A4/A5)

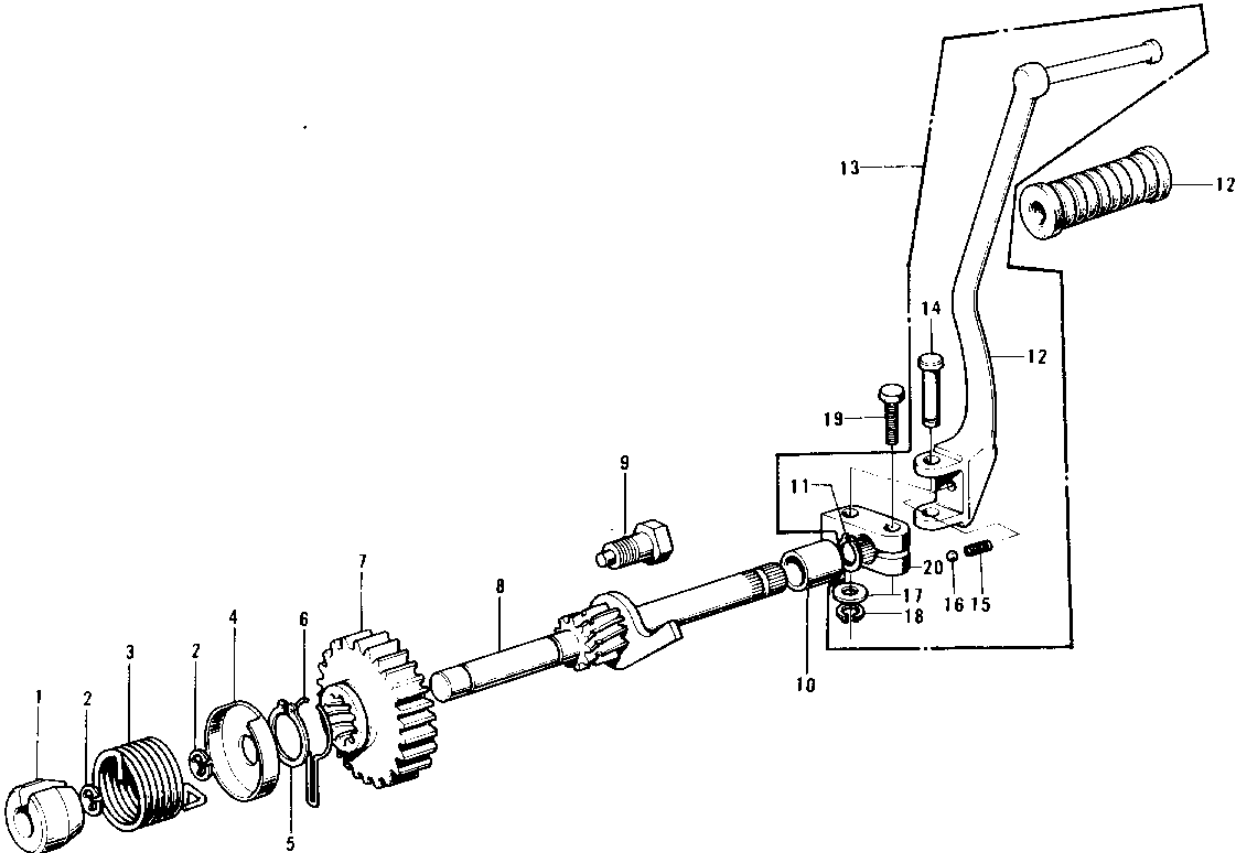

1977 KH400-A4 PARTS LIST

KICKSTARTER MECHANISM ('76-'78 A3/A4/A5)

ITEM NAME	PART NUMBER	QUANTITY
GUIDE KICK SPRING (Ref # 1)	13070-001	1
CIRCLIP 10MM (Ref # 2)	482J0100	1
SPRING KICKSTARTER (Ref # 3)	92081-021	1
PLATE KICK GEAR HLDER (Ref # 4)	13071-003	1
CIRCLIP 26MM (Ref # 5)	480J2600	1
HOLDER KICK GEAR (Ref # 6)	13077-002	1
GEAR-KICKSTARTER (Ref # 7)	13068-024	1
SHAFT,KICKSTARTER (Ref # 8)	13245-008	1
STOPPER KICKSTARTER (Ref # 9)	13072-006	1
BUSH (Ref # 10)	92028-072	1
CIRCLIP 16MM (Ref # 11)	480J1600	1
RUBBER KICK PEDAL (Ref # 12)	13063-004	1
PEDAL-KICKSTARTER (Ref # 13)	13058-038	1
PIN-KICKSTARTER PEDAL (Ref # 14)	92043-068	1
SPRING KICK PEDAL (Ref # 15)	92081-020	1
BALL STEEL 1/4' (Ref # 16)	600A0800	1
WASHER PLAIN 10MM (Ref # 17)	410B1000	1
CIRCLIP 8MM (Ref # 18)	482J8000	1
BOLT-KICK PEDAL (Ref # 19)	92001-101	1
BOSS-KICK PEDAL (Ref # 20)	13061-015	1