

## 1976 KH400-A3 PARTS DIAGRAM

GEAR CHANGE MECHANISM ('76-'78 A3/A4/A5)

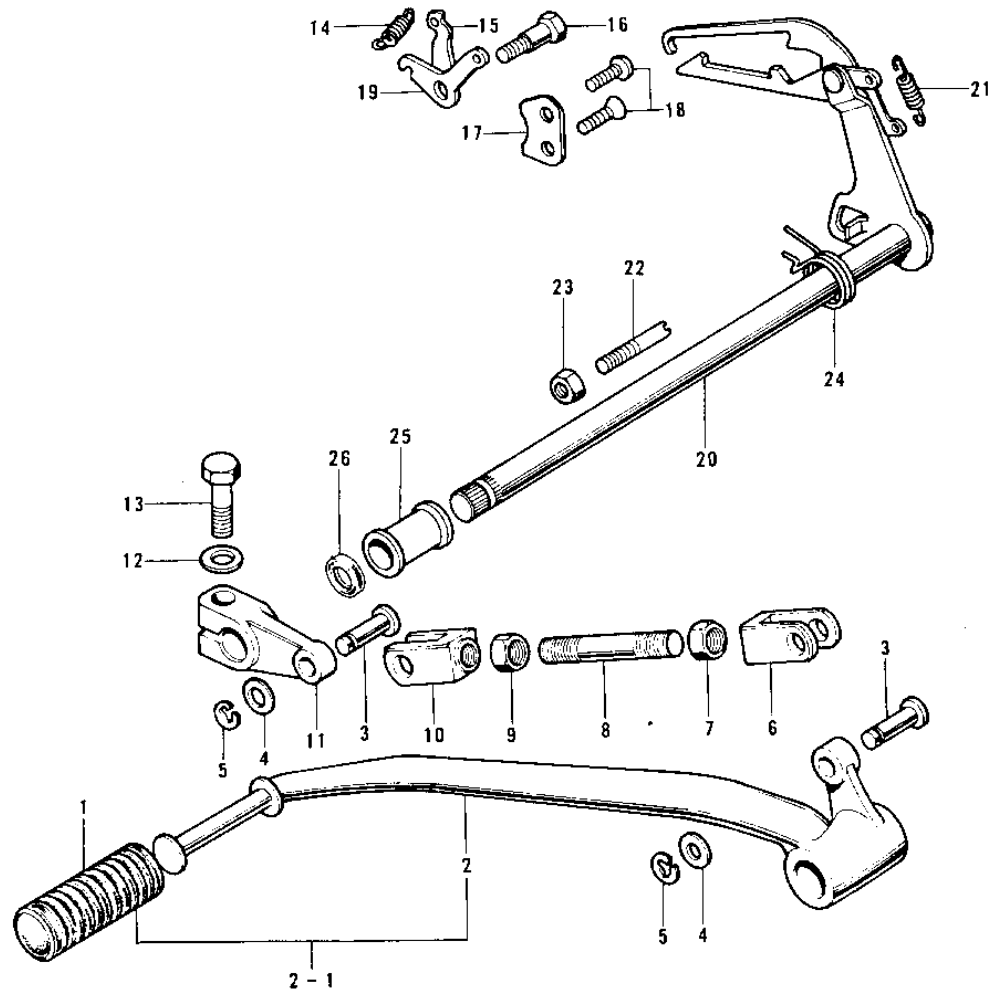

## 1976 KH400-A3 PARTS LIST

GEAR CHANGE MECHANISM ('76-'78 A3/A4/A5)

ITEM NAME	PART NUMBER	QUANTITY
RUBBER CHANGE PEDAL (Ref # 1)	13157-004	1
PEDAL ASY,GEAR CHANGE (Ref # 2)	13242-009	2
PIN (Ref # 3)	92043-069	1
WASHER,PLAIN (Ref # 4)	92022-1028	1
CIRCLIP 5MM (Ref # 5)	482K5000	1
CONNECTOR,B (Ref # 6)	13159-008	1
NUT,8MM (Ref # 7)	92017-010	1
ROD (Ref # 8)	92003-074	1
NUT,8MM (Ref # 9)	318N0800	1
CONNECTOR,A (Ref # 10)	13159-007	1
LEVER-GEAR CHANGE (Ref # 11)	13158-007	1
WASHER SPRING 8MM (Ref # 12)	461F0800	1
BOLT,8X25 (Ref # 13)	114N0825	1
SPRING-COIL (Ref # 14)	92081-091	1
PLATE-CHNG DRUM LEVER (Ref # 15)	13170-005	1
SCREW-PAN HEAD (Ref # 16)	92011-023	1
PLATE-DRUM LEV POSTON (Ref # 17)	13169-007	1
SCREW CNTSNK HD 6X16 (Ref # 18)	221B0616	1
LEVER ASSY-CHNG RETRN (Ref # 19)	13236-002	1
LEVER ASSY GEAR CHNG (Ref # 20)	13161-036	1
SPRING,CHANGE LEVER (Ref # 21)	92144-1720	1
BOLT,RETURN SPRING (Ref # 22)	92001-1401	1
NUT 8MM (Ref # 23)	312B0800	1
SPRING,TENTION (Ref # 24)	92081-1129	2
DUST SHIELD-CHNG SHT (Ref # 25)	13171-004	1
SEAL-OIL (Ref # 26)	92049-1249	1