

1979 KDX400 PARTS DIAGRAM

BRAKE PEDAL/TORQUE LINK

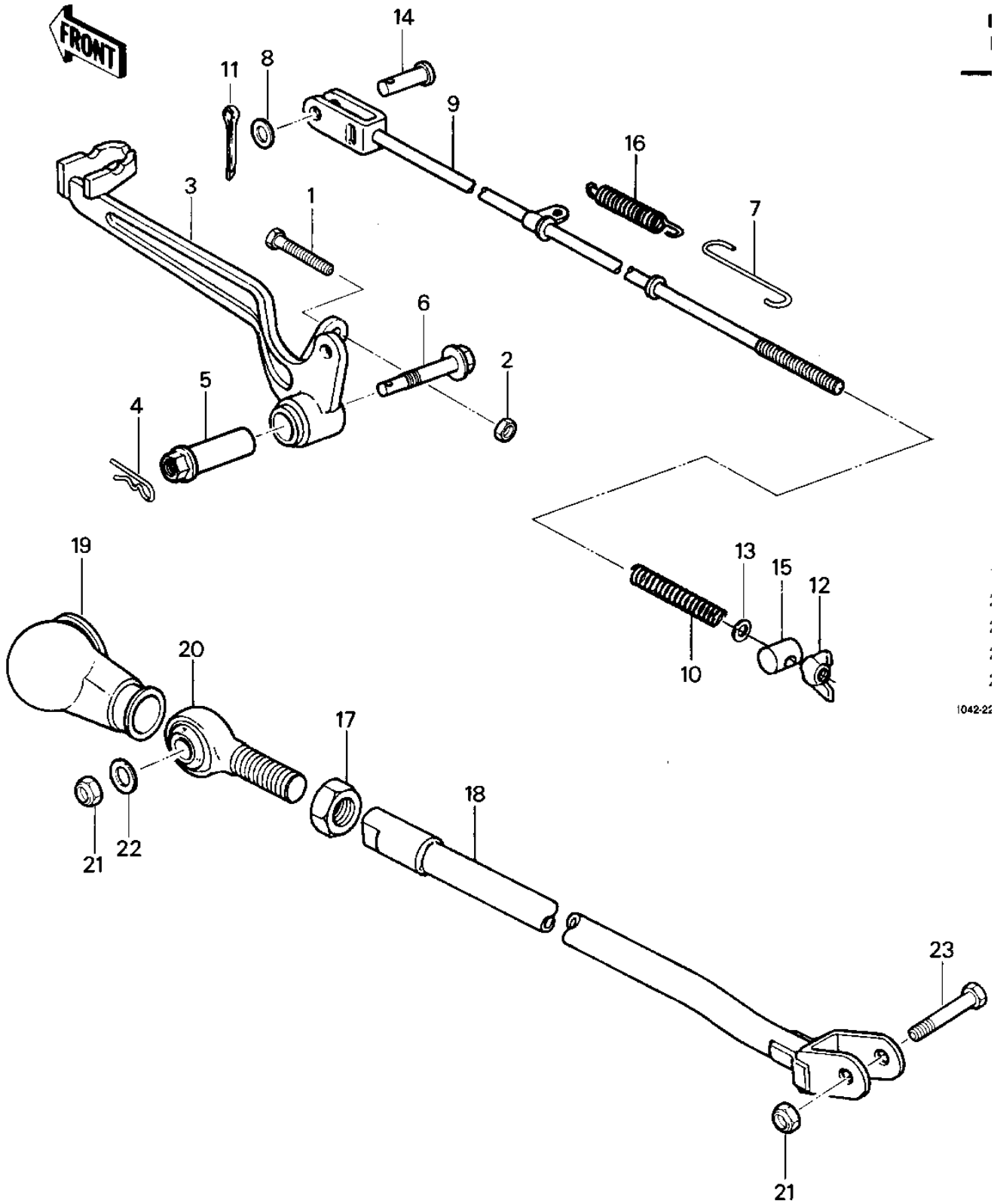

1979 KDX400 PARTS LIST

BRAKE PEDAL/TORQUE LINK

ITEM NAME	PART NUMBER	QUANTITY
BOLT 6X22 (Ref # 1)	112B0622	1
NUT 6MM (Ref # 2)	311B0600	1
LEVER,REAR BRAKE (Ref # 3)	43001-4002	1
PIN,SNAP (Ref # 4)	554A0800	1
BOLT,HEX HEAD,12M/M (Ref # 5)	92001-1035	1
BOLT HEX HEAD,12M/M (Ref # 6)	92001-1036	1
HOOK (Ref # 7)	27012-4001	1
WASHER PLAIN 6MM (Ref # 8)	410B0600	1
ROD,BRAKE (Ref # 9)	43011-4001	1
SPRING,BRAKE ROD (Ref # 10)	43012-001	1
PIN COTTER 2.0X15 (Ref # 11)	550D2015	1
NUT,WING,6M/M (Ref # 12)	92015-4004	1
WASHER, BRAKE ROD (Ref # 13)	92022-4003	1
PIN-BRAKE ROD FITTING (Ref # 14)	92043-064	1
PIN,BRAKE (Ref # 15)	92043-1024	1
SPRING,BRAKE PEDAL (Ref # 16)	92081-1025	1
NUT 12MM (Ref # 17)	312B1200	1
ROD,TORQUE (Ref # 18)	43007-4001	1
BOOT (Ref # 19)	49006-4001	1
JOINT,BALL,NTN-SMR112 (Ref # 20)	59266-4001	1
NUT,LOCK,8MM (Ref # 21)	92015-1124	1
WASHER CHNG DRUM LEV (Ref # 22)	92022-091	1
BOLT,HEX HEAD,8X36 (Ref # 23)	92001-1041	1