

1969 Samurai PARTS DIAGRAM

REAR HUB/BRAKE

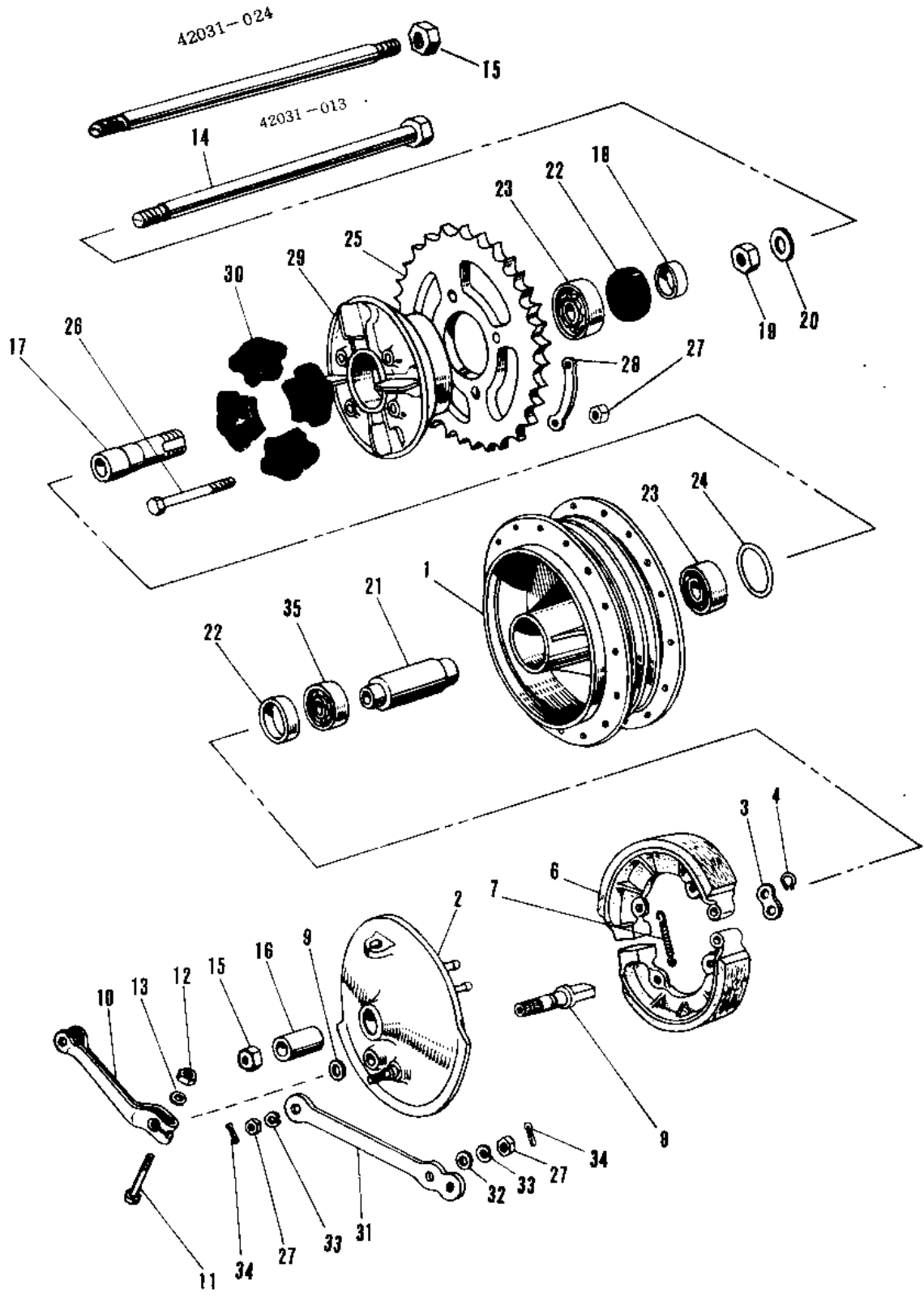

1969 Samurai PARTS LIST

REAR HUB/BRAKE

ITEM NAME	PART NUMBER	QUANTITY
DRUM ASSY REAR BRAKE (Ref # 1,21,2)	42005-009	1
PANEL-ASY,RR BRK,BUFF (Ref # 2~13)	42006-007-80	1
WASHER,BRAKE SHOE (Ref # 3)	41045-007	1
CIRCLIP 14MM (Ref # 4)	480J1400	2
SHOE REAR BRAKE (Ref # 6)	42019-003	2
SPRING BRAKE SHOE (Ref # 7)	41049-003	1
CAM SHAFT,REAR BRAKE (Ref # 8)	42026-015	1
DUST SHIELD BRAKE CAM (Ref # 9)	41051-001	1
LEVER,REAR BRAKE CAM (Ref # 10)	42029-037	1
BOLT-UPSET,6X40 (Ref # 11)	112G0640	1
NUT 6MM (Ref # 12)	311B0600	1
WASHER PLAIN 6MM (Ref # 13)	411B0600	1
AXLE REAR (Ref # 14)	42031-013	(1
AXLE-REAR (Ref # 14)	42031-033	1
UNAVAILABLE IN PRICE BOOK (Ref # 15)	313Z1600	2
COLLAR REAR HUB R.H (Ref # 16)	42032-008	1
SLEEVE REAR AXLE (Ref # 17)	42036-006	1
COLLER RR AXLE SLEEVE (Ref # 18)	42037-006	1
NUT SLEEVE (Ref # 19)	42045-006	1
WASHER SLEEVE (Ref # 20)	42046-009	1
SPACER RR HUB BEARING (Ref # 21)	42010-008	1
OIL SEAL WTC35527 (Ref # 22)	92052-006	1
BEARING BALL #6205 (Ref # 23)	601B6205	2
"0" RING,60MM (Ref # 24)	671B2560	1
REAR SPROCKET 37T (Ref # 25)	42041-028	1
BOLT-REAR SPROCKET (Ref # 26)	92003-087	4
NUT,10MM (Ref # 27)	314B1000	6
WASHER SPROCKET LOCK (Ref # 28)	92088-005	2
COUPLING ASSY,RR HUB (Ref # 17~19,)	42008-012	1

1969 Samurai PARTS LIST

REAR HUB/BRAKE

ITEM NAME	PART NUMBER	QUANTITY
DAMPER REAR HUB SHOCK (Ref # 30)	42014-008	4
TORQUE LINK REAR BRK (Ref # 31)	43007-010	1
WASHER PLAIN 10MM (Ref # 32)	411B1000	1
WASHER SPRING 10MM (Ref # 33)	461F1000	2
PIN COTTER 2.0X20 (Ref # 34)	550D2020	2
BEARING BALL #6205Z (Ref # 35)	601B6205Z	1