

1968 Samurai PARTS DIAGRAM

FRONT HUB/BRAKE

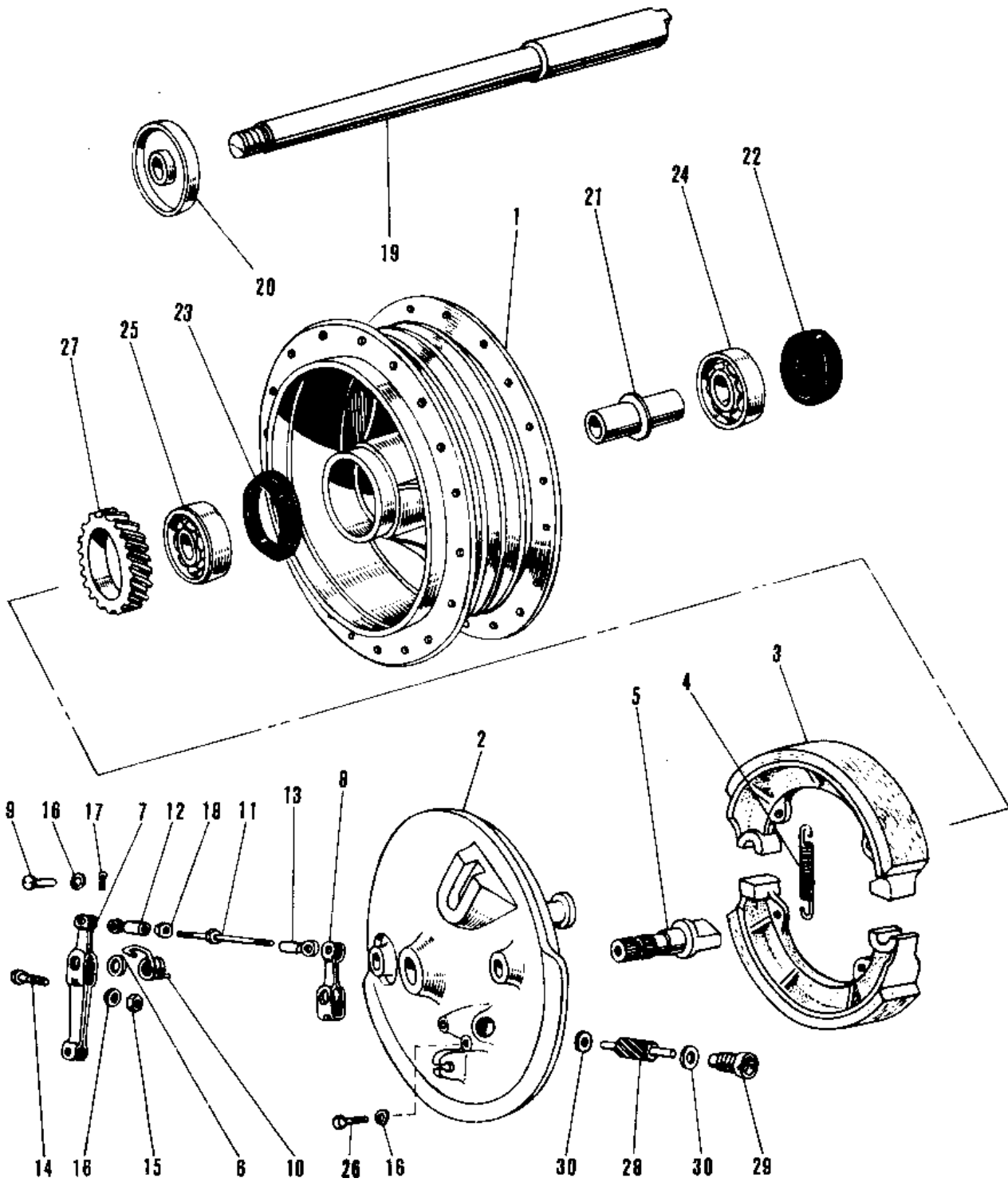

1968 Samurai PARTS LIST

FRONT HUB/BRAKE

ITEM NAME	PART NUMBER	QUANTITY
FRONT BRAKE DRUM COMPLETE (Ref # 1,21~2)	41034-007	1
PANEL-ASY,FR BRK BUFF (Ref # 2~18,2)	41035-066-80	1
SHOE,BRAKE (Ref # 3)	41048-019	2
SPRING FRNT BRK SHOE (Ref # 4)	41049-004	2
CAM SHAFT FRONT BRAKE (Ref # 5)	41050-004	2
DUST SHIELD BRAKE CAM (Ref # 6)	41051-001	2
LEVER FRT BRK CAM 1ST (Ref # 7)	41053-011	1
LEVER FRT BRK CAM 2ND (Ref # 8)	41053-012	1
PIN BRAKE CONNECT ROD (Ref # 9)	41055-003	2
SPRING FR BRK CAM LEV (Ref # 10)	41056-001	1
ROD BRK CAM LEV CONCT (Ref # 11)	41057-001	1
ROD BRK CAM LEV CONCT (Ref # 11)	41057-004	1
ROD END BRK CONNECT A (Ref # 12)	41058-002	1
ROD END,BRK CONNECT (Ref # 12)	41058-008	1
ROD END BRK CONNECT B (Ref # 13)	41058-003	1
ROD END,BRK CONNECT (Ref # 13)	41058-009	1
BOLT-UPSET (Ref # 14)	112G0630	2
NUT 6MM (Ref # 15)	311B0600	2
WASHER PLAIN 6MM (Ref # 16)	411B0600	5
PIN COTTER 1.2X10 (Ref # 17)	550D1210	2
NUT,5MM (Ref # 18)	311B0500	1
NUT,5MM (Ref # 18)	311B0500	1
AXLE FRONT (Ref # 19)	41068-015	1
AXLE FRONT (Ref # 19)	41068-016	1
COLLAR F AXL OIL SEAL (Ref # 20)	41069-007	1
SPACER F AXLE BEARING (Ref # 21)	41039-011	1
OIL SEAL WTC25428 (Ref # 22)	92052-005	1
OIL SEAL WOC55687 (Ref # 23)	92050-017	1
BEARING BALL #6302 (Ref # 24)	601B6302	1

1968 Samurai PARTS LIST

FRONT HUB/BRAKE

ITEM NAME	PART NUMBER	QUANTITY
BEARING BALL #6302Z (Ref # 25)	601B6302Z	1
BOLT-UPSET (Ref # 26)	112G0618	1
GEAR SPEEDOMETER (Ref # 27)	41059-009	1
PINION SPEEDOMETER (Ref # 28)	41060-007	1
BUSH SPEDMETER PINION (Ref # 29)	41062-003	1
WASHER PINION THRUST (Ref # 30)	41063-003	2