

1967 Avenger PARTS DIAGRAM

FOOTRESTS/STANDS/BRAKE PEDAL

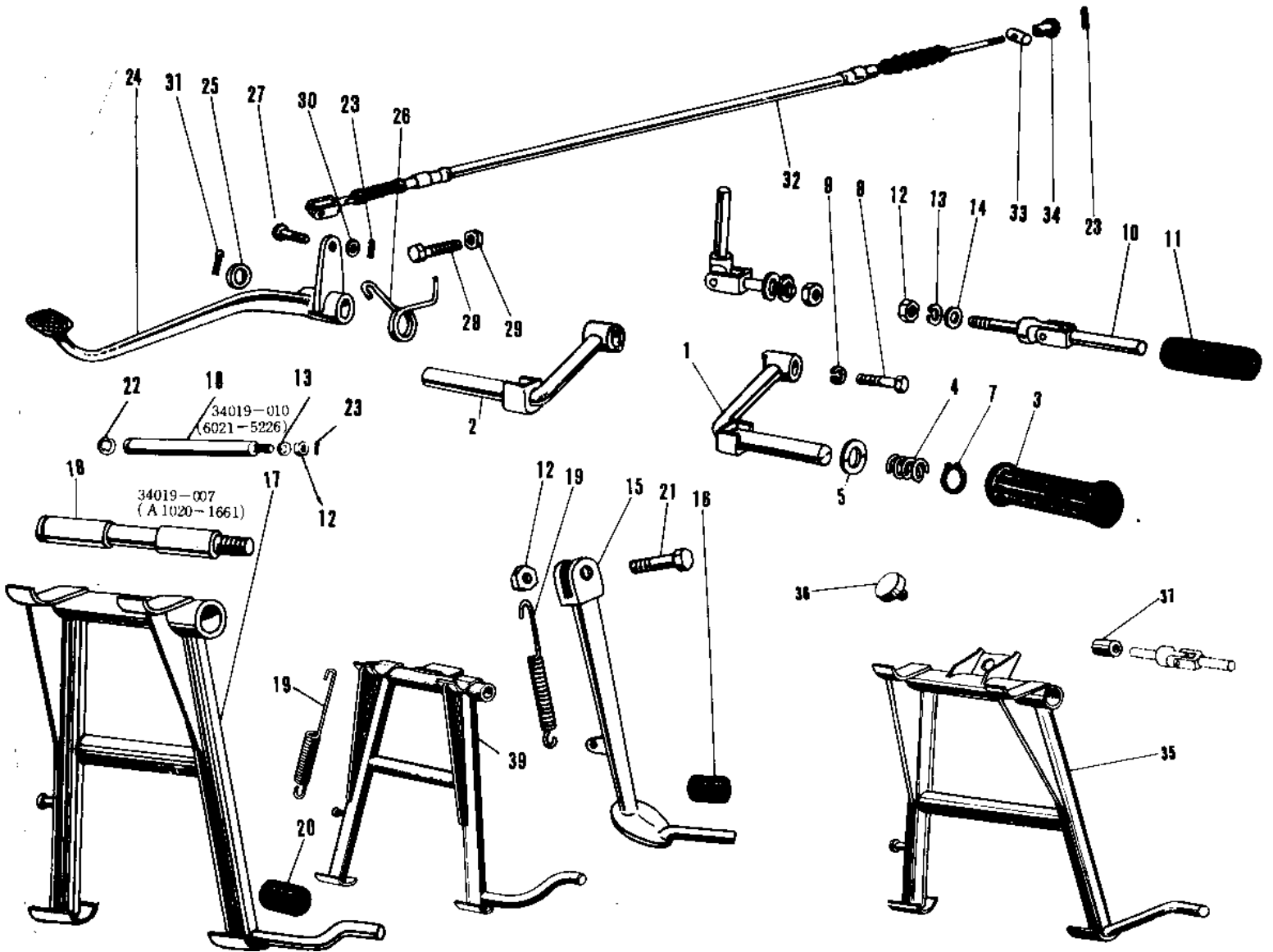

1967 Avenger PARTS LIST

FOOTRESTS/STANDS/BRAKE PEDAL

ITEM NAME	PART NUMBER	QUANTITY
BAR FOOTREST L.H (Ref # 1)	34003-001	1
BAR FOOTREST R.H (Ref # 2)	34003-002	1
RUBBER FOOTREST (Ref # 3)	92076-010	2
SPRING FOOTREST PEG (Ref # 4)	34006-002	2
WASHER FOLDING PEG (Ref # 5)	92022-049	2
CIRCLIP 16MM (Ref # 7)	480J1600	2
BOLT HEX HEAD 12X40 (Ref # 8)	113B1240	2
BOLT HEX HEAD 12X40 (Ref # 8)	113B1240	2
WASHER SPRING 12MM (Ref # 9)	461F1200	2
BAR R.H REAR FOOTREST (Ref # 10)	34027-007	2
RUBBER REAR FOOTREST (Ref # 11)	92076-009	2
NUT,10MM (Ref # 12)	314B1000	4
WASHER SPRING 10MM (Ref # 13)	461F1000	3
WASHER PLAIN 10MM (Ref # 14)	410B1000	2
STAND-SIDE (Ref # 15)	34024-016	1
DAMPER RUBB SIDE STND (Ref # 16)	92075-031	1
STAND-MAIN (Ref # 17)	34011-019	1
SHAFT MAIN STAND (Ref # 18)	34019-010	1
SPRING MAIN STAND (Ref # 19)	34023-005	2
DAMPER RUBB-MAIN STND (Ref # 20)	92075-115	1
BOLT HEX HEAD 10X32 (Ref # 21)	113B1032	1
CIRCLIP 15MM (Ref # 22)	482K0300	1
PIN COTTER 2.0X15 (Ref # 23)	550D2015	3
PEDAL BRAKE (Ref # 24)	43001-025	1
WASHER BRAKE PEDAL (Ref # 25)	92022-085	1
SPRING BRAKE PEDAL (Ref # 26)	43005-007	1
PIN R BRK CABLE JOINT (Ref # 27)	92043-034	1
BOLT-UPSET (Ref # 28)	112G0625	1
NUT 6MM (Ref # 29)	311B0600	1

1967 Avenger PARTS LIST

FOOTRESTS/STANDS/BRAKE PEDAL

ITEM NAME	PART NUMBER	QUANTITY
WASHER PLAIN 6MM (Ref # 30)	410B0600	1
PIN COTTER 3.0X20 (Ref # 31)	550D3020	1
CABLE REAR BRAKE (Ref # 32)	54022-005	1
PIN BRAKE ROD (Ref # 33)	92043-053	1
NUT-BRAKE CABLE ADJST (Ref # 34)	92015-041	1
STAND-MAIN (Ref # 39)	34011-019	1