

1968 Avenger PARTS DIAGRAM

SWING ARM/SHOCK ABSORBERS A1A-A7SSA

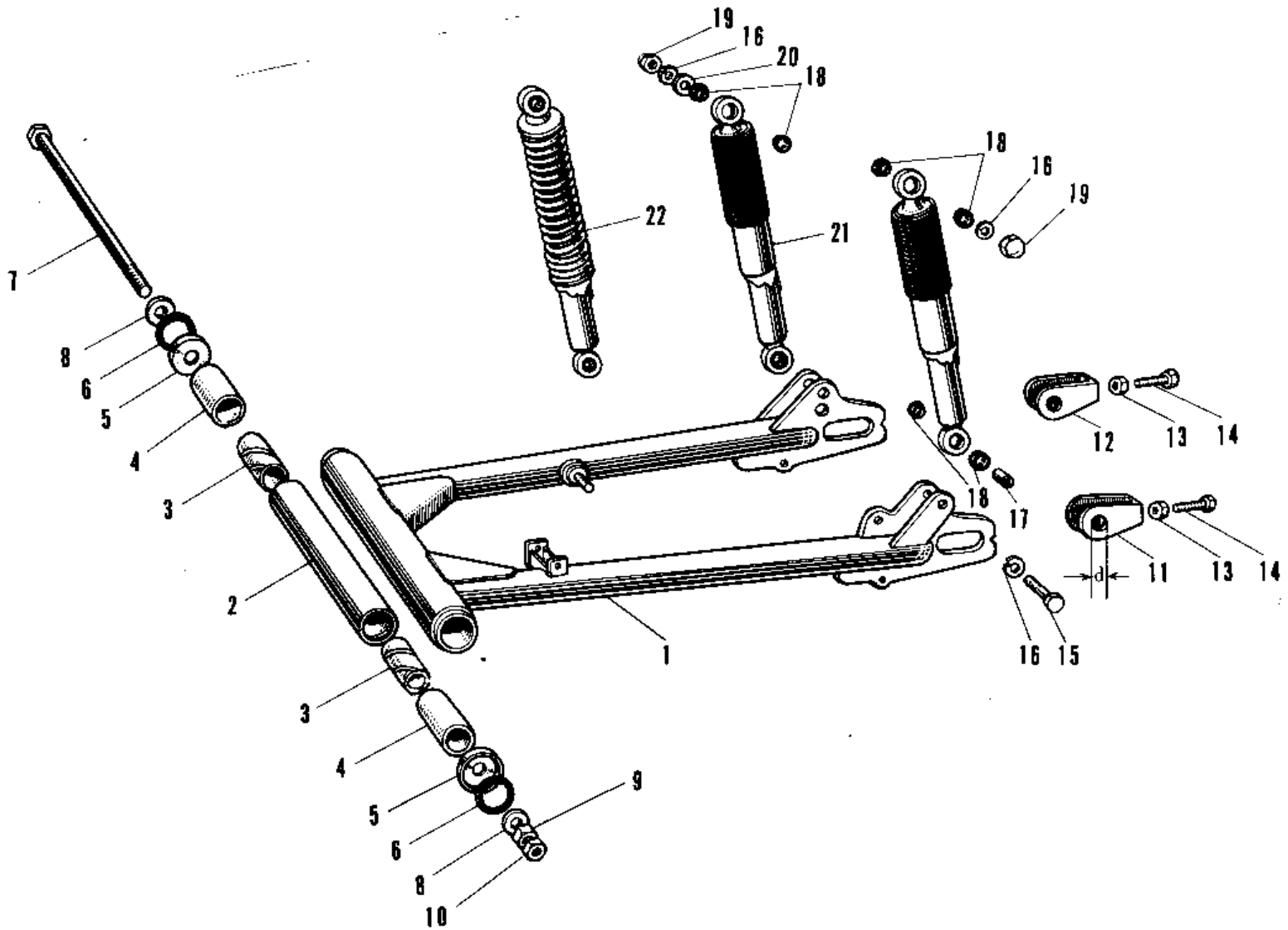

1968 Avenger PARTS LIST

SWING ARM/SHOCK ABSORBERS A1A-A7SSA

ITEM NAME	PART NUMBER	QUANTITY
ARM-SWING (Ref # 1)	33001-030	1
SLEEVE-SWING ARM LONG (Ref # 2)	33034-014	1
SLEEVE-SWING ARM,SHRT (Ref # 3)	33034-013	2
BUSH-SWING ARM (Ref # 4)	33033-008	2
HOLDER DUST SHIELD (Ref # 5)	33035-001	2
DUST SHIELD PIVOT SFT (Ref # 6)	92093-004	2
SHAFT SWING ARM PIVOT (Ref # 7)	33032-012	1
WASHER PLAIN 14MM (Ref # 8)	410B1400	2
NUT,14MM (Ref # 9)	314B1400	1
NUT 14MM (Ref # 10)	315B1400	1
ADJUSTER CHAIN L.H (Ref # 11)	33040-032	1
ADJUSTER CHAIN R.H (Ref # 12)	33040-033	1
NUT 8MM (Ref # 13)	312B0800	2
BOLT,8X50 (Ref # 14)	92001-1399	2
BOLT HEX HEAD 10X35 (Ref # 15)	113N1035	2
WASHER SPRING 10MM (Ref # 16)	461F1000	4
BUSH SHCK ABS PVT SFT (Ref # 17)	45016-003	2
BUSH SHCK ABS RUBBER (Ref # 18)	45017-001	8
NUT SHOCK ABSORBER (Ref # 19)	92020-003	2
WASHER-PL-10.5X26X2.3 (Ref # 20)	92022-044	1
UNAVAILABLE IN PRICE BOOK (Ref # 21)	45015-002-10	2
SHOCK ABSORBER REAR (Ref # 22)	45014-024	*2