

1968 Avenger SS PARTS DIAGRAM

SWING ARM/SHOCK ABSORBERS A1-A7SS

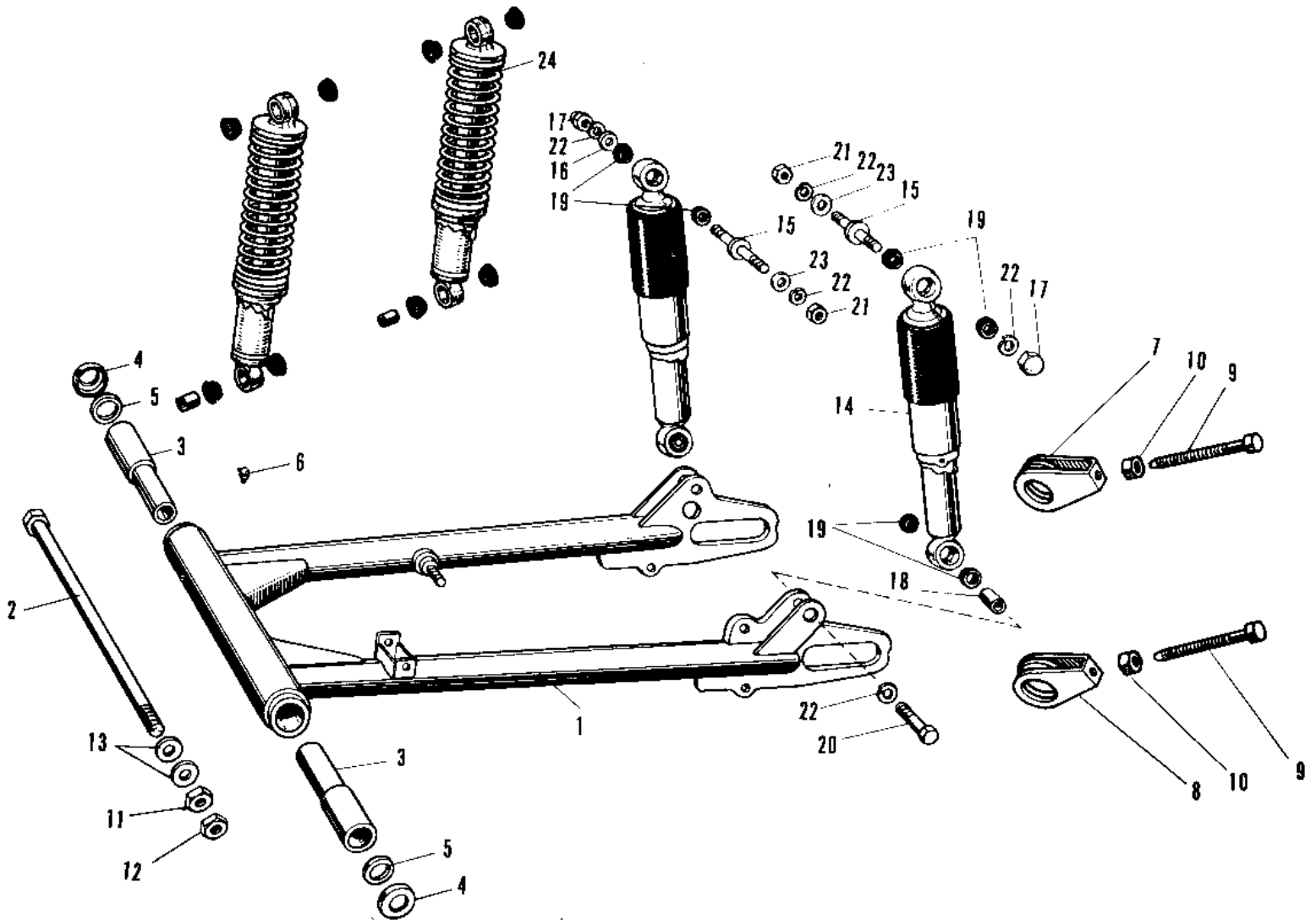

1968 Avenger SS PARTS LIST

SWING ARM/SHOCK ABSORBERS A1-A7SS

ITEM NAME	PART NUMBER	QUANTITY
ARM NET-NWING (Ref # 1)	33002-015	1
SHAFT SWING ARM PIVOT (Ref # 2)	33032-012	1
SLEEVE SWING ARM SHT (Ref # 3)	33034-002	(2)
SLEEVE SWING ARM SHT (Ref # 3)	33034-003	2
DUST SHIELD PIVOT SFT (Ref # 4)	92093-004	2
HOLDER DUST SHIELD (Ref # 5)	33035-001	2
GREASE NIPPLE (Ref # 6)	92005-002	1
ADJUSTER CHAIN R.H (Ref # 7)	33040-022	1
ADJUSTER CHAIN R.H (Ref # 7)	33040-033	1
ADJUSTER SET-CHAIN,L (Ref # 8)	33043-001	1
ADJUSTER CHAIN L.H (Ref # 8)	33040-032	1
BOLT CHAIN ADJUST (Ref # 9)	92001-009	2
BOLT,8X50 (Ref # 9)	92001-1399	2
NUT 6MM (Ref # 10)	312B0600	2
NUT 8MM (Ref # 10)	312B0800	2
NUT,14MM (Ref # 11)	314B1400	1
NUT 14MM (Ref # 12)	315B1400	1
WASHER PLAIN 14MM (Ref # 13)	410B1400	2
WASHER-PL-10.5X26X2.3 (Ref # 16)	92022-044	1
NUT SHOCK ABSORBER (Ref # 17)	92020-003	2
BUSH SHCK ABS PVT SFT (Ref # 18)	45016-003	2
BUSH SHCK ABS RUBBER (Ref # 19)	45017-001	8
BOLT HEX HEAD 10X35 (Ref # 20)	113N1035	2
NUT,10MM (Ref # 21)	314B1000	2
WASHER SPRING 10MM (Ref # 22)	461F1000	6
WASHER PLAIN 10MM (Ref # 23)	411B1000	2
SHOCK ABSORBER REAR (Ref # 24)	45014-024	*2