

1968 Avenger PARTS DIAGRAM

FRAME A1/SS, A7/SS, U.S. MODELS

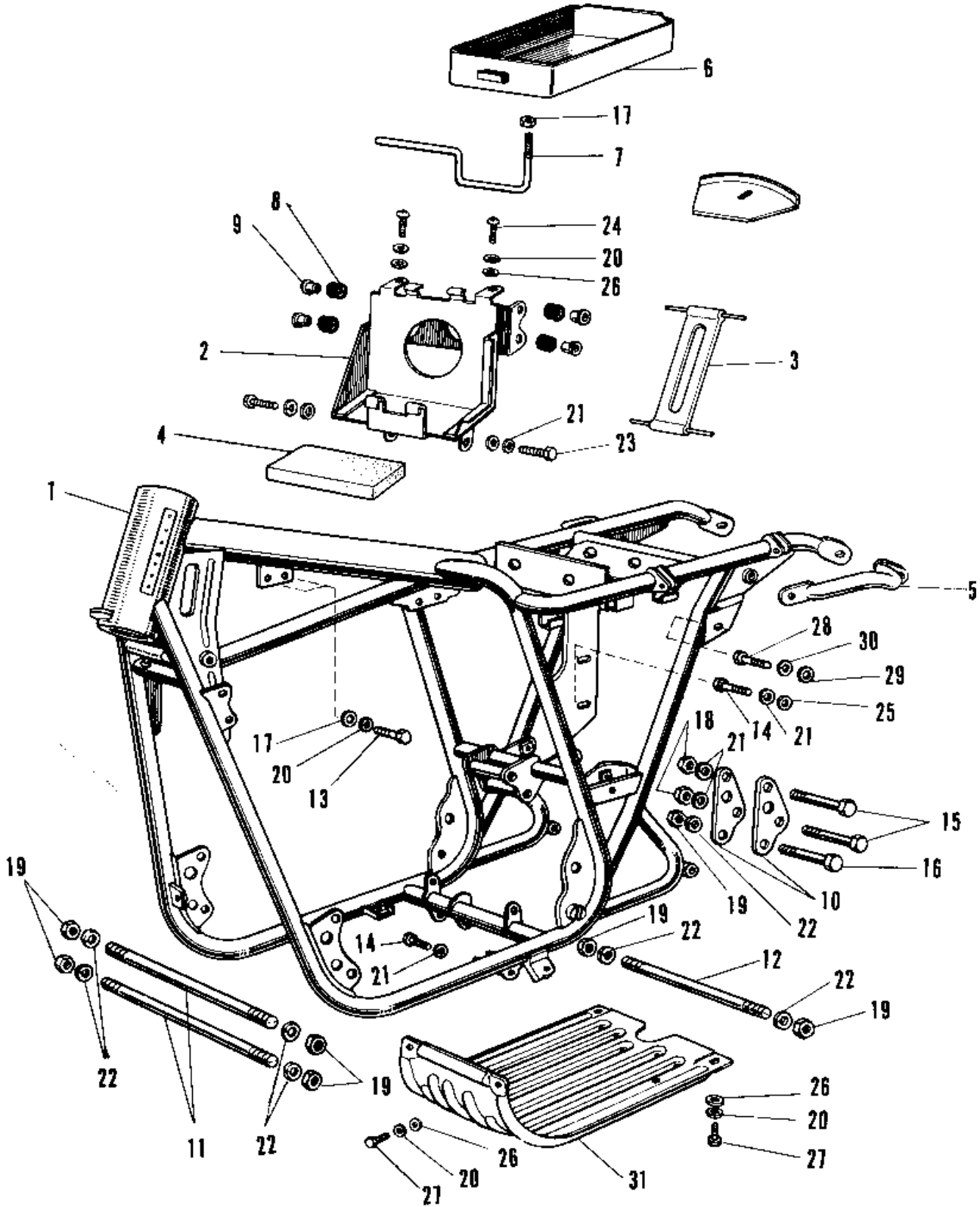

1968 Avenger PARTS LIST

FRAME A1/SS, A7/SS, U.S. MODELS

ITEM NAME	PART NUMBER	QUANTITY
FRAME (Ref # 1)	32002-020	1
CASE BATTERY (Ref # 2)	32097-007	1
BAND BATTERY (Ref # 3)	92072-015	1
MAT BATTERY (Ref # 4)	32103-006	1
GRIP FRAME (Ref # 5)	32109-004	1
BOX TOOL (Ref # 6)	32098-004	(1
BOX TOOL (Ref # 6)	32098-010	1
STAY TOOL BOX (Ref # 7)	32110-001	1
GROMMET IGN UNIT FIT (Ref # 8)	92071-037	4
WASHER IGN UNIT FIT (Ref # 9)	92026-056	4
PLATE ENG REAR HOLDER (Ref # 10)	32030-006	2
BOLT,10X225 (Ref # 11)	92003-181	2
BOLT ENG LOWER MOUNT (Ref # 12)	92091-003	1
BOLT 6X35 (Ref # 13)	110R0635	4
BOLT-SMALL-UPSET,8X18 (Ref # 14)	115G0818	2
BOLT FLANGED,8X70 (Ref # 15)	92001-1583	2
BOLT,FLANGED,10X70 (Ref # 16)	92001-1618	(1
BOLT,FLANGED,10X70 (Ref # 16)	92001-1618	1
NUT 6MM (Ref # 17)	311B0600	5
NUT,8MM (Ref # 18)	311B0800	2
NUT,10MM (Ref # 19)	314B1000	7
WASHER SPRING 6MM (Ref # 20)	461F0600	10
WASHER SPRING 8MM (Ref # 21)	461F0800	6
WASHER SPRING 10MM (Ref # 22)	461F1000	7
BOLT-SMALL-UPSET,8X16 (Ref # 23)	115G0816	2
SCREW PAN HEAD 6X12 (Ref # 24)	220B0612	2
WASHER PLAIN 6MM (Ref # 26)	410B0600	6
BOLT-UPSET,6X12 (Ref # 27)	112G0612	4