

1970 A7SS-A PARTS DIAGRAM

FRAME A1/SS, A7/SS

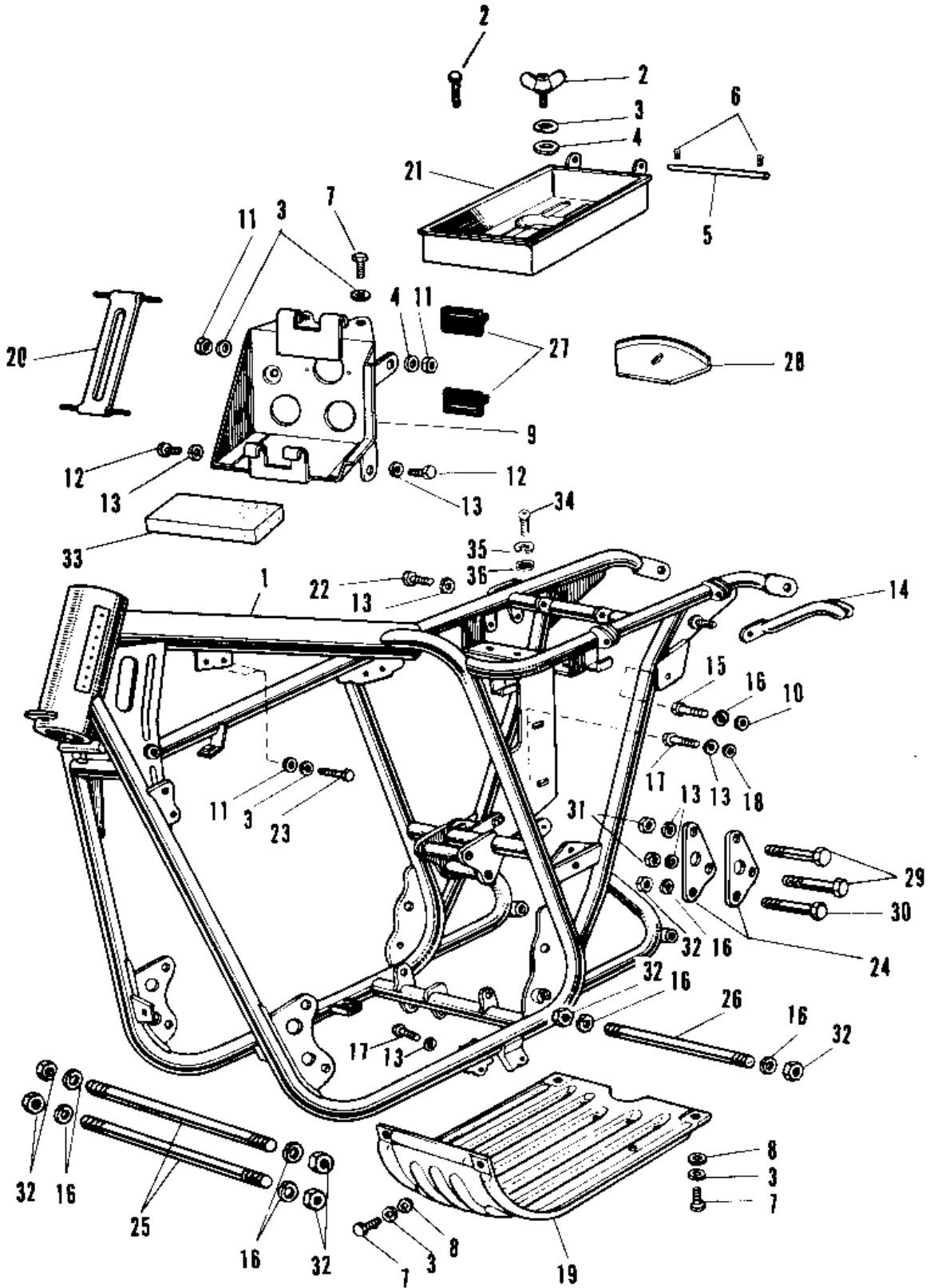

1970 A7SS-A PARTS LIST

FRAME A1/SS, A7/SS

ITEM NAME	PART NUMBER	QUANTITY
FRAME (Ref # 1)	32002-028	1
SCREW PAN HEAD 6X12 (Ref # 2)	220B0612	1
WASHER SPRING 6MM (Ref # 3)	461F0600	12
WASHER PLAIN 6MM (Ref # 4)	411B0600	2
PIN OIL TANK FITTING (Ref # 5)	92043-020	1
PIN COTTER 1.6X10 (Ref # 6)	550D1610	2
BOLT-UPSET,6X12 (Ref # 7)	112G0612	6
WASHER PLAIN 6MM (Ref # 8)	411B0600	4
(Ref # 9)	32097-004	1
WASHER PLAIN 10MM (Ref # 10)	410B1000	1
NUT 6MM (Ref # 11)	311B0600	6
BOLT HEX HEAD 8X16 (Ref # 12)	116B0816	2
WASHER SPRING 8MM (Ref # 13)	461F0800	7
GRIP FRAME (Ref # 14)	32109-004	1
BOLT,HEX HEAD,10X25 (Ref # 15)	113G1025	1
WASHER SPRING 10MM (Ref # 16)	461F1000	8
BOLT-SMALL-UPSET,8X18 (Ref # 17)	115G0818	2
WASHER PLAIN 8MM (Ref # 18)	411B0800	2
ENGINE GUARD (Ref # 19)	55011-005	1
BAND BATTERY (Ref # 20)	92072-015	1
BOX TOOL (Ref # 21)	32098-002	1
BOLT-SMALL-UPSET,8X16 (Ref # 22)	115G0816	1
BOLT-UPSET,6X35 (Ref # 23)	112G0635	4
PLATE ENG REAR HOLDER (Ref # 24)	32030-006	2
BOLT,10X225 (Ref # 25)	92003-181	2
BOLT ENG LOWER MOUNT (Ref # 26)	92091-003	1
SEAT RECTIFIER RUBBER (Ref # 27)	32103-003	2
COVER AIR CLEANER (Ref # 28)	32104-002	1
BOLT FLANGED,8X70 (Ref # 29)	92001-1583	2

1970 A7SS-A PARTS LIST

FRAME A1/SS, A7/SS

ITEM NAME	PART NUMBER	QUANTITY
BOLT,FLANGED,10X70 (Ref # 30)	92001-1618	(1
BOLT,FLANGED,10X70 (Ref # 30)	92001-1618	1
NUT,8MM (Ref # 31)	311B0800	2
NUT,10MM (Ref # 32)	314B1000	7
MAT BATTERY (Ref # 33)	32103-006	1
SCREW PAN HEAD 6X10 (Ref # 34)	220B0610	1
WASHER SPRING 6MM (Ref # 35)	461F0600	1
WASHER PLAIN 6MM (Ref # 36)	410B0600	1