

1968 Samurai PARTS DIAGRAM

FRAME A1/SS, A7/SS

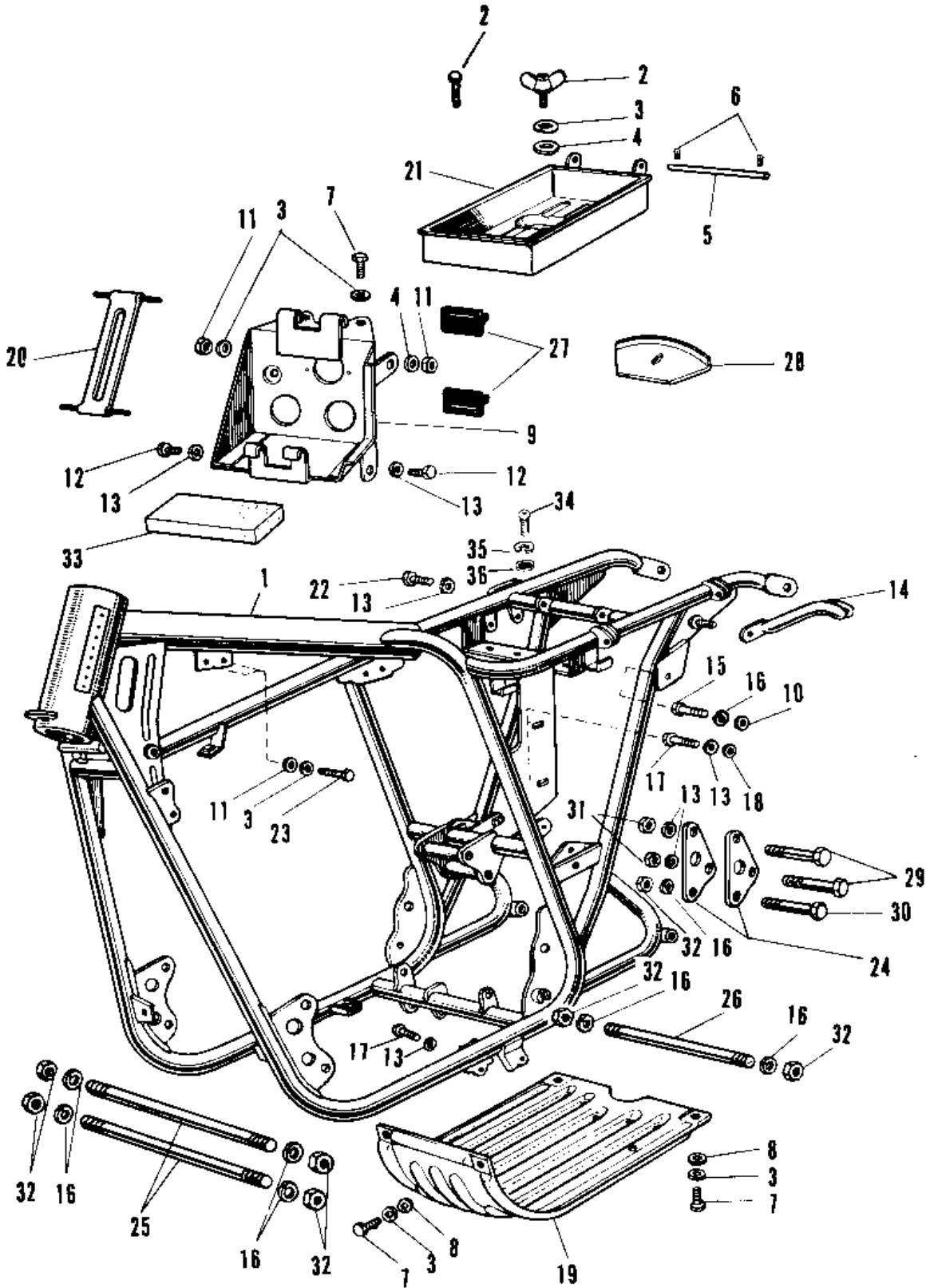

1968 Samurai PARTS LIST

FRAME A1/SS, A7/SS

ITEM NAME	PART NUMBER	QUANTITY
FRAME (Ref # 1)	32002-028	1
SCREW PAN HEAD 6X12 (Ref # 2)	220B0612	1
WASHER SPRING 6MM (Ref # 3)	461F0600	2
WASHER PLAIN 6MM (Ref # 4)	411B0600	2
PIN OIL TANK FITTING (Ref # 5)	92043-020	1
PIN COTTER 1.6X10 (Ref # 6)	550D1610	1
BOLT-UPSET,6X12 (Ref # 7)	112G0612	1
(Ref # 9)	32097-004	1
NUT 6MM (Ref # 11)	311B0600	1
BOLT HEX HEAD 8X16 (Ref # 12)	116B0816	1
WASHER SPRING 8MM (Ref # 13)	461F0800	1
GRIP FRAME (Ref # 14)	32109-004	1
WASHER SPRING 10MM (Ref # 16)	461F1000	1
BOLT-SMALL-UPSET,8X18 (Ref # 17)	115G0818	1
BAND BATTERY (Ref # 20)	92072-015	1
BOX TOOL (Ref # 21)	32098-002	1
BOLT-SMALL-UPSET,8X16 (Ref # 22)	115G0816	1
BOLT-UPSET,6X35 (Ref # 23)	112G0635	1
PLATE ENG REAR HOLDER (Ref # 24)	32030-006	1
BOLT,10X225 (Ref # 25)	92003-181	1
BOLT ENG LOWER MOUNT (Ref # 26)	92091-003	1
SEAT RECTIFIER RUBBER (Ref # 27)	32103-003	1
COVER AIR CLEANER (Ref # 28)	32104-002	1
BOLT FLANGED,8X70 (Ref # 29)	92001-1583	1
BOLT,FLANGED,10X70 (Ref # 30)	92001-1618	2
NUT,8MM (Ref # 31)	311B0800	1
NUT,10MM (Ref # 32)	314B1000	1
MAT BATTERY (Ref # 33)	32103-006	1
SCREW PAN HEAD 6X10 (Ref # 34)	220B0610	1

1968 Samurai PARTS LIST

FRAME A1/SS, A7/SS

ITEM NAME	PART NUMBER	QUANTITY
WASHER PLAIN 6MM (Ref # 36)	410B0600	1