

1969 Avenger PARTS DIAGRAM

OIL PUMP

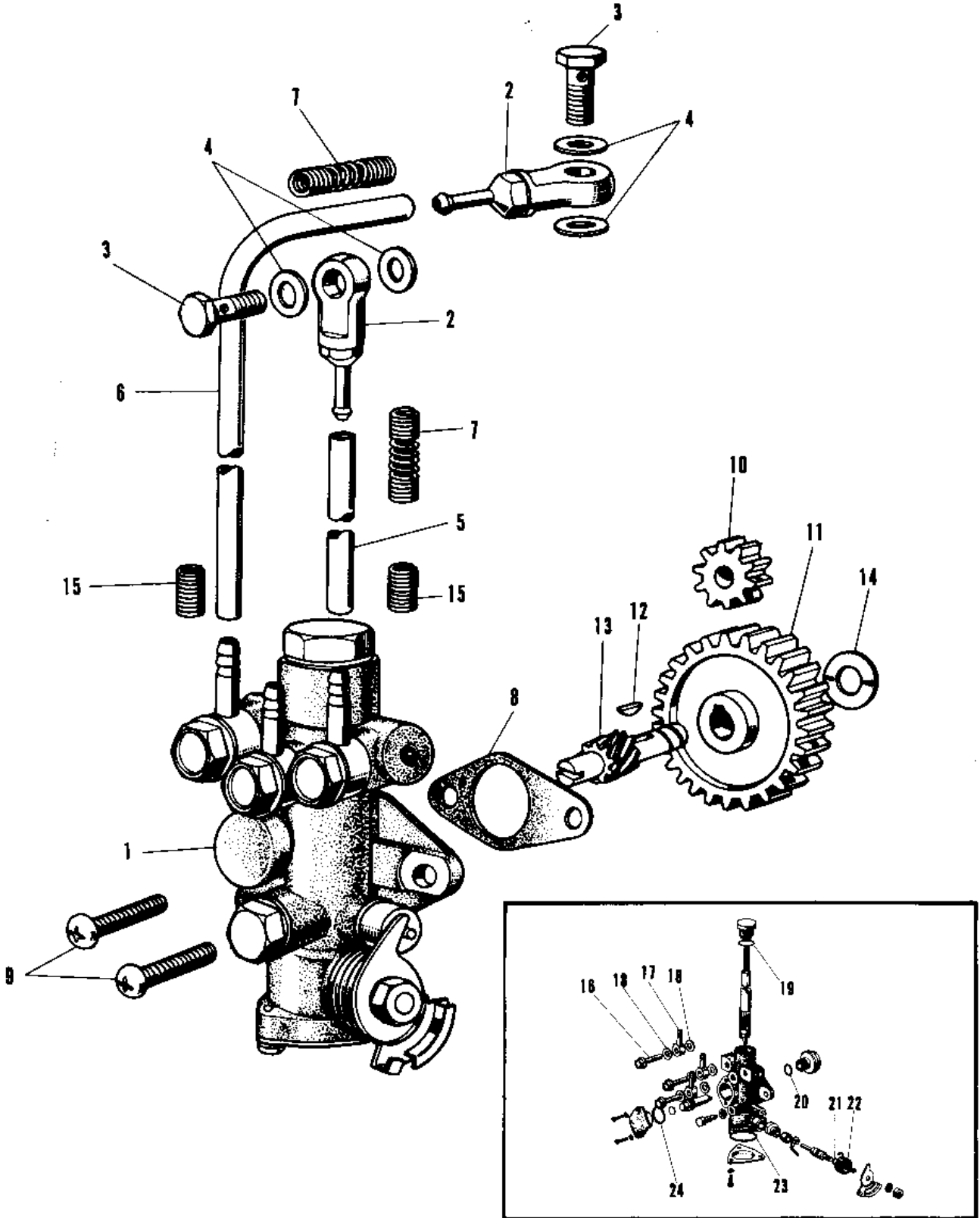

1969 Avenger PARTS LIST

OIL PUMP

ITEM NAME	PART NUMBER	QUANTITY
OIL PUMP ASSY (Ref # 1)	16082-013	1
CHECK VALVE (Ref # 2)	16087-002	2
BOLT BANJO 8X21 (Ref # 3)	92060-014	2
GASKET 8MM (Ref # 4)	751P0800	(4
GASKET CHECK VALVE (Ref # 4)	92065-023	4
PIPE OIL A (Ref # 5)	92059-015	1
PIPE OIL B (Ref # 6)	92059-013	1
SPRING PIPE CLAMP A (Ref # 7)	92081-025	2
GASKET OIL PUMP (Ref # 8)	16094-007	1
SCREW PAN HEAD 5X12 (Ref # 9)	220B0512	2
SCREW PAN HEAD 5X12 (Ref # 9)	220B0512	2
PINION OIL PUMP (Ref # 10)	16084-005	1
UNAVAILABLE IN PRICE BOOK (Ref # 11)	16085-0005	1
WOODRUFF KEY (Ref # 12)	510A3100	1
PINION TACHOMETER (Ref # 13)	13224-001	1
WASHER THRUST (Ref # 14)	92026-025	1
SPRING PIPE CLAMP B (Ref # 15)	92081-027	2
BOLT-BANJO,6MM (Ref # 16)	92060-013	3
CONNECTOR BANJO (Ref # 17)	92061-009	3
WASHER OIL PUMP BANJO (Ref # 18)	92022-077	6
"0" RING,HOUSING (Ref # 19)	16088-001	1
"0" RING,PMP GEAR (Ref # 20)	16092-001	1
SEAL-OIL,CAMSHAFT,"X" (Ref # 21)	92049-1294	1
SPRING OIL PUMP LEVER (Ref # 22)	16093-002	1
"0" RING,PMP CAM SHT (Ref # 23)	16091-002	1
"0" RING,WORM GEAR (Ref # 24)	16090-001	1