

1967 Samurai PARTS DIAGRAM

CARBURETOR VM22SC, VM28SC

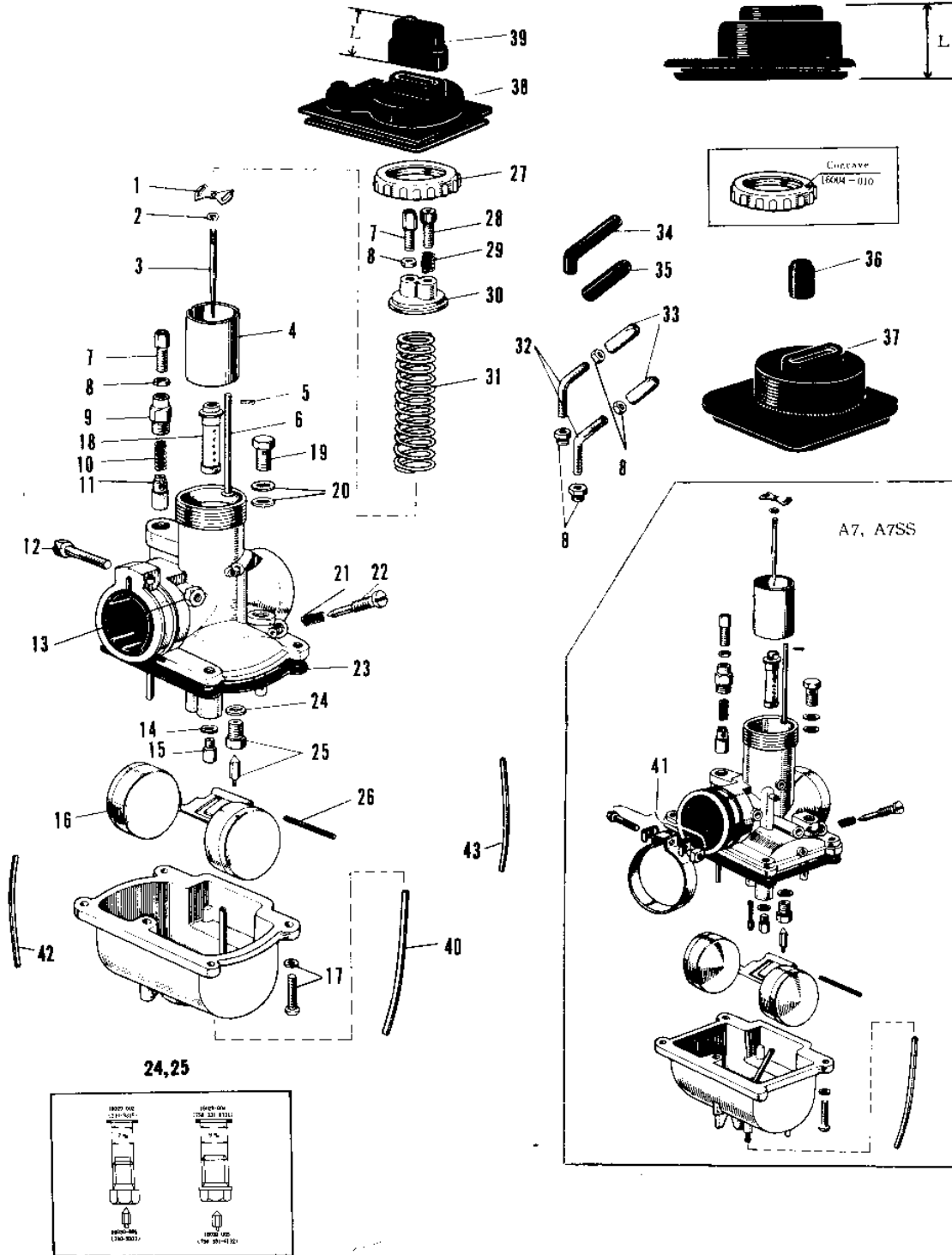

1967 Samurai PARTS LIST

CARBURETOR VM22SC, VM28SC

ITEM NAME	PART NUMBER	QUANTITY
CARBURETOR ASSY R.H (Ref # 1~31)	16001-096	1
CARBURETOR ASSY L.H (Ref # 1~31)	16001-097	1
SPRING SEAT THRTL VLV (Ref # 1)	16007-002	2
CIRCLIP (Ref # 2)	16008-010	2
JET NEEDLE 4J13 (Ref # 3)	16009-012	2
VALVE THROTTLE (Ref # 4)	16025-011	2
UNAVAILABLE IN PRICE BOOK (Ref # 5)	16023-001	2
ROD THROTTLE VLV STOP (Ref # 6)	16024-002	2
CABLE ADJUSTER (Ref # 7)	16002-002	2
NUT CABLE ADJUST LOCK (Ref # 8)	16003-004	6
CAP STARTER PLUNGER (Ref # 9)	16012-004	2
SPRING STARTER PLUNG (Ref # 10)	16013-005	2
PLUNGER-ENRICHNER (Ref # 11)	16016-002	2
SCREW CLAMP (Ref # 12)	16010-004	2
NUT 6MM (Ref # 13)	311B0600	(2)
NUT 6MM (Ref # 13)	311B0600	2
WASHER MAIN JET (Ref # 14)	16034-001	2
JET-MAIN NO 140A (Ref # 15)	92063-015	2
FLOAT (Ref # 16)	16031-004	2
SCREW FLOAT CHAMBER (Ref # 17)	16033-009	8
NEEDLE JET 0-6 (Ref # 18)	16017-026	2
BOLT BANJO (Ref # 19)	92001-014	2
GASKET 8MM (Ref # 20)	751P0800	4
SPRING, THROTTLE ADJST (Ref # 21)	16022-010	2
SCREW PILOT AIR ADJST (Ref # 22)	16014-003	2
GASKET FLOAT CHAMBER (Ref # 23)	16019-004	2
WASHER VALVE SEAT (Ref # 24)	16029-002	2
WASHER FLOAT VLV SEAT (Ref # 24)	16029-004	2
FLOAT VALVE ASSY (Ref # 25)	16030-001	2

1967 Samurai PARTS LIST

CARBURETOR VM22SC, VM28SC

ITEM NAME	PART NUMBER	QUANTITY
FLOAT VALVE ASSY (Ref # 25)	16030-005	2
FLOAT PIN (Ref # 26)	16032-003	2
CAP MIXING CHAMBER (Ref # 27)	16004-010	2
SCREW, THROTTLE STOP (Ref # 28)	16021-002	2
SPRING THR STOP SCREW (Ref # 29)	16022-005	2
TOP MIXING CHAMBER (Ref # 30)	16005-005	2
SPRING THROTTLE VALVE (Ref # 31)	16006-013	2
CABLE GUIDE (Ref # 32)	16077-001	2
CABLE ADJUSTER (Ref # 33)	16002-004	2
CAP CABLE ADJUSTER A (Ref # 34)	16036-002	1
CAP CABLE ADJUSTER B (Ref # 35)	16036-003	1
CAP THROTTLE ADJUSTER (Ref # 36)	16037-002	1
CAP L.H CARBURETOR (Ref # 37)	14038-009	1
CAP CARBURETOR (Ref # 38)	14038-008	1
GROMMET CARB CAP (Ref # 39)	14038-006	1
PIPE FUEL OVERFLOW (Ref # 40)	92059-031	2
PIPE AIR VENT A (Ref # 42)	92059-040	1
PIPE AIR VENT B (Ref # 43)	92059-044	1