

1968 A1SS PARTS DIAGRAM

KICKSTARTER MECHANISM

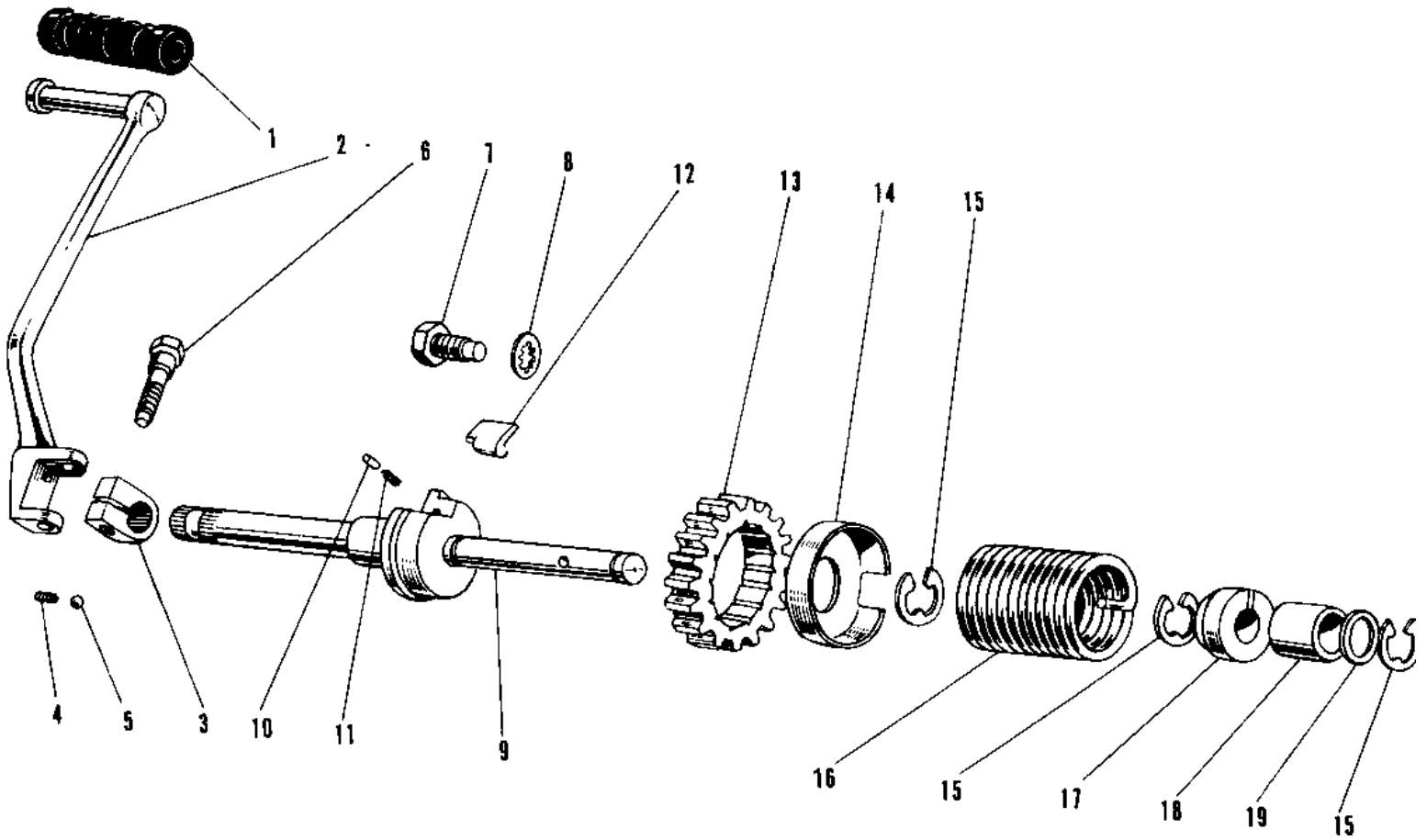

1968 A1SS PARTS LIST

KICKSTARTER MECHANISM

ITEM NAME	PART NUMBER	QUANTITY
RUBBER KICK PEDAL (Ref # 1)	13063-004	1
PEDAL,KICKSTARTER (Ref # 2~6)	13064-016	1
BOSS KICK PEDAL (Ref # 3)	13061-007	1
SPRING KICK PEDAL (Ref # 4)	92081-020	1
BALL STEEL 1/4' (Ref # 5)	600A0800	1
BOLT 10MM (Ref # 6)	92001-071	1
STOPPER KICKSTARTER (Ref # 7)	13072-006	1
WASHER LOCK 12MM (Ref # 8)	463G1200	1
SHAFT KICKSTARTER (Ref # 9)	13066-008	1
PIN KICKSTARTER PAWL (Ref # 10)	92042-001	1
SPRING KICK PAWL (Ref # 11)	92081-022	1
PAWL KICKSTARTER (Ref # 12)	13069-006	1
GEAR KICKSTARTER (Ref # 13)	13068-009	1
PLATE KICK GEAR HLDER (Ref # 14)	13071-003	1
CIRCLIP 10MM (Ref # 15)	482J0100	3
SPRING KICKSTARTER (Ref # 16)	92081-021	1
GUIDE KICK SPRING (Ref # 17)	13070-001	1
BUSH KICKSTARTER SFT (Ref # 18)	92028-044	1
WASHER 13MM (Ref # 19)	92022-073	1