

1970 Avenger PARTS DIAGRAM

CLUTCH

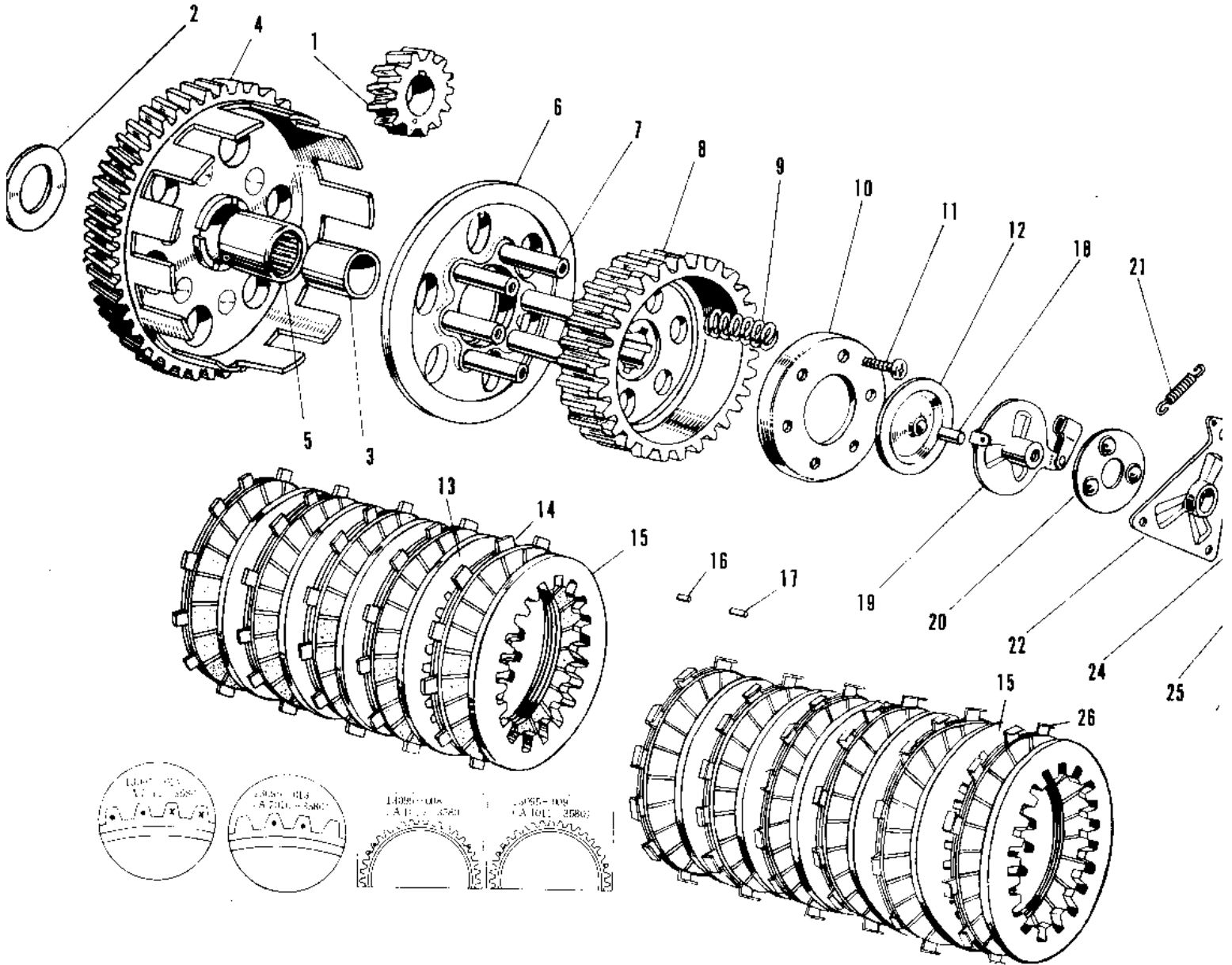

1970 Avenger PARTS LIST

CLUTCH

ITEM NAME	PART NUMBER	QUANTITY
PINION PRIMARY (Ref # 1)	13121-009	1
WASHER TH 25.5X47X2.5 (Ref # 2)	92026-022	1
BUSH CLUTCH (Ref # 3)	92028-045	1
CLUTCH-ASSY (Ref # 4~17 4)	13082-011	1
HOUSING CLUTCH (Ref # 4)	13095-014	1
BEARING NEEDLE (Ref # 5)	92046-004	1
BASE CLUTCH (Ref # 6)	13086-011	1
STUD CLUTCH BASE (Ref # 7)	92004-009	1
HUB CLUTCH (Ref # 8)	13087-019	1
SPRING CLUTCH (Ref # 9)	92081-023	1
PLATE CLUTCH SPRING (Ref # 10)	13091-005	1
SCREW PAN HEAD 6X16 (Ref # 11)	220B0616	1
PUSHER CLUTCH SPRING (Ref # 12)	13113-004	1
PLATE CLUTCH STEEL (Ref # 13)	13089-007	1
PLATE CLUTCH FRICTION (Ref # 14)	13088-008	1
PLATE CLUTCH OUTER (Ref # 15)	13090-006	1
RUBBER RETURN SHORT (Ref # 16)	13093-001	1
RUBBER RETURN LONG (Ref # 17)	13093-004	1
PIN DOWEL 7X10 (Ref # 18)	610A0710	1
PLATE CLUTCH RELEASE (Ref # 19)	13102-006	1
THRUST BALL ASSY CLTH (Ref # 20)	13110-003	1
SPRING GEAR CHNG LEV (Ref # 21)	92083-011	1
PLATE CLTH RELESE CAM (Ref # 22)	13119-003	1
SCREW PAN HEAD 6X12 (Ref # 23)	220B0612	1
SCREW SLOTTED (Ref # 24)	291Z0622	1
NUT 6MM (Ref # 25)	312B0600	1