

1978 KLR250 PARTS DIAGRAM

FUEL TANK/SIDE COVERS

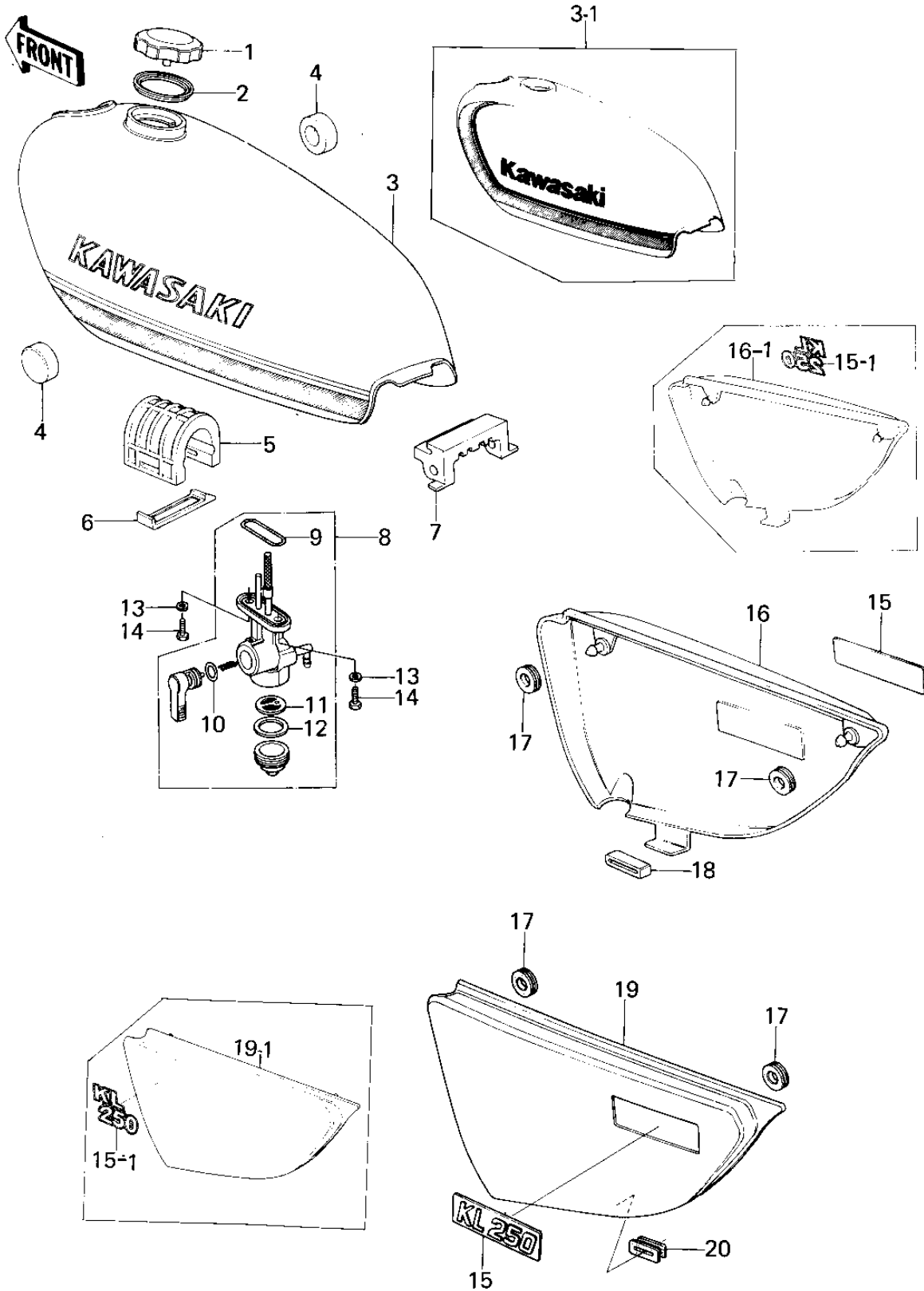

1978 KLR250 PARTS LIST

FUEL TANK/SIDE COVERS

ITEM NAME	PART NUMBER	QUANTITY
CAP,FUEL TANK (Ref # 1)	51048-1013	1
GASKET,FUEL TANK CAP (Ref # 2)	51059-011	1
TANK-FUEL,FLAME RED (Ref # 3)	51001-1002-7P	1
TANK-FUEL,MARINE BLUE (Ref # 3-1)	51001-5015-B4	1
DAMPER RUBBER-FL TANK (Ref # 4)	92075-101	2
DAMPER RUBBER,FL TNK (Ref # 5)	92075-215	1
BAND,FUEL TANK (Ref # 6)	92072-1013	1
DAMPER,FUEL TANK,REAR (Ref # 7)	92075-1001	1
TAP ASSY,FUEL (Ref # 8)	51023-1001	1
"O" RING (Ref # 9)	51039-003	1
"O" RING, 10MM (Ref # 10)	670B2010	1
STRINER,FUEL TAP (Ref # 11)	14043-1002	1
GASKET,FUEL TAP CUP (Ref # 12)	11009-1013	1
WASHER-PLAIN (Ref # 13)	92022-183	2
BOLT-HEX HEAD,6X16 (Ref # 14)	92001-114	2
MARK,SIDE COVER (Ref # 15)	56018-1013	2
MARK,SIDE COVER (Ref # 15-1)	56018-1033	2
COVER,SIDE,RH F.RED (Ref # 16)	36001-1044-7P	1
COVER,SIDE,R.H.M.BLUE (Ref # 16-1)	36001-1044-6N	1
GROMMET (Ref # 17)	92071-056	4
DAMPER,SIDE COVER (Ref # 18)	92075-1034	1
COVER,SIDE,L.H,F.RED (Ref # 19)	36001-1043-7P	1
COVER,SIDE,L.H.M.BLUE (Ref # 19-1)	36001-1043-6N	1
GROMMET,SIDE COVER (Ref # 20)	92071-1004	1