

# 1979 KLR250 PARTS DIAGRAM

REAR HUB/BRAKE

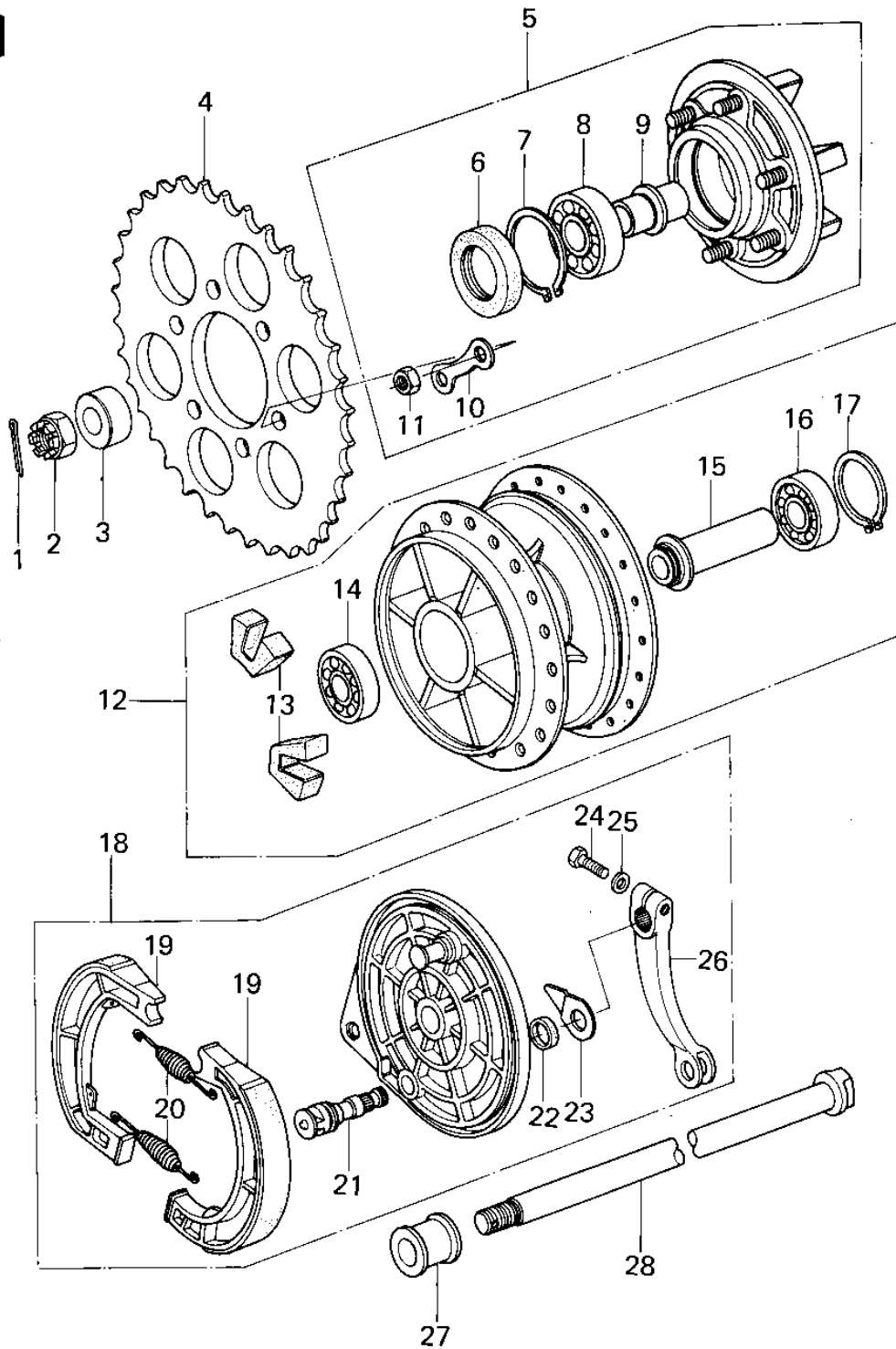

# 1979 KLR250 PARTS LIST

## REAR HUB/BRAKE

ITEM NAME	PART NUMBER	QUANTITY
PIN-COTTER,4.0X35 (Ref # 1)	550D4035	1
NUT CASTLE,16MM (Ref # 2)	92015-055	1
COLLAR,REAR AXLE,L.H. (Ref # 3)	92027-1010	1
REAR SPROCKET,39T (Ref # 4)	42041-163	1
COUPLING ASSY,REAR HB (Ref # 5)	42008-030	1
OIL SEAL WTC35527 (Ref # 6)	92052-006	1
RING,SNAP,56.2M/M (Ref # 7)	92033-1043	1
BEARING BALL #6205 (Ref # 8)	601B6205	1
SLEEVE,COUPLING (Ref # 9)	42036-023	1
WASHER LOCK (Ref # 10)	92088-007	3
NUT 10MM (Ref # 11)	42045-005	6
DRUM ASSY,REAR BRAKE (Ref # 12)	42005-052	1
DAMPER,REAR HUB SHOCK (Ref # 13)	42014-024	6
BEARING BALL #6303 (Ref # 14)	601B6303	1
COLLAR,REAR HUB BEARG (Ref # 15)	42010-038	1
BEARING-BALL (Ref # 16)	601B6303U	1
CIRCLIP,47M/M (Ref # 17)	92033-1042	1
PANEL-ASY,RR BRK (Ref # 18)	41035-1004	1
SHOE,BRAKE (Ref # 19)	42019-011	2
SPRING-BRAKE SHOE (Ref # 20)	42020-004	2
CAM SHAFT,REAR BRAKE (Ref # 21)	41050-1003	1
DUST SHIELD BRAKE CAM (Ref # 22)	41051-001	1
INDICATOR,FR BRK SHOE (Ref # 23)	41085-017	1
BOLT-UPSET (Ref # 24)	112G0625	1
WASHER PLAIN 6MM (Ref # 25)	410B0600	1
LEVER,REAR BRAKE CAM (Ref # 26)	42029-040	1
COLLAR,REAR AXLE,R.H. (Ref # 27)	92027-1009	1
AXLE,REAR (Ref # 28)	41068-1003	1