

1979 KLR250 PARTS DIAGRAM

CAMSHAFT/CHAIN/TENSIONER

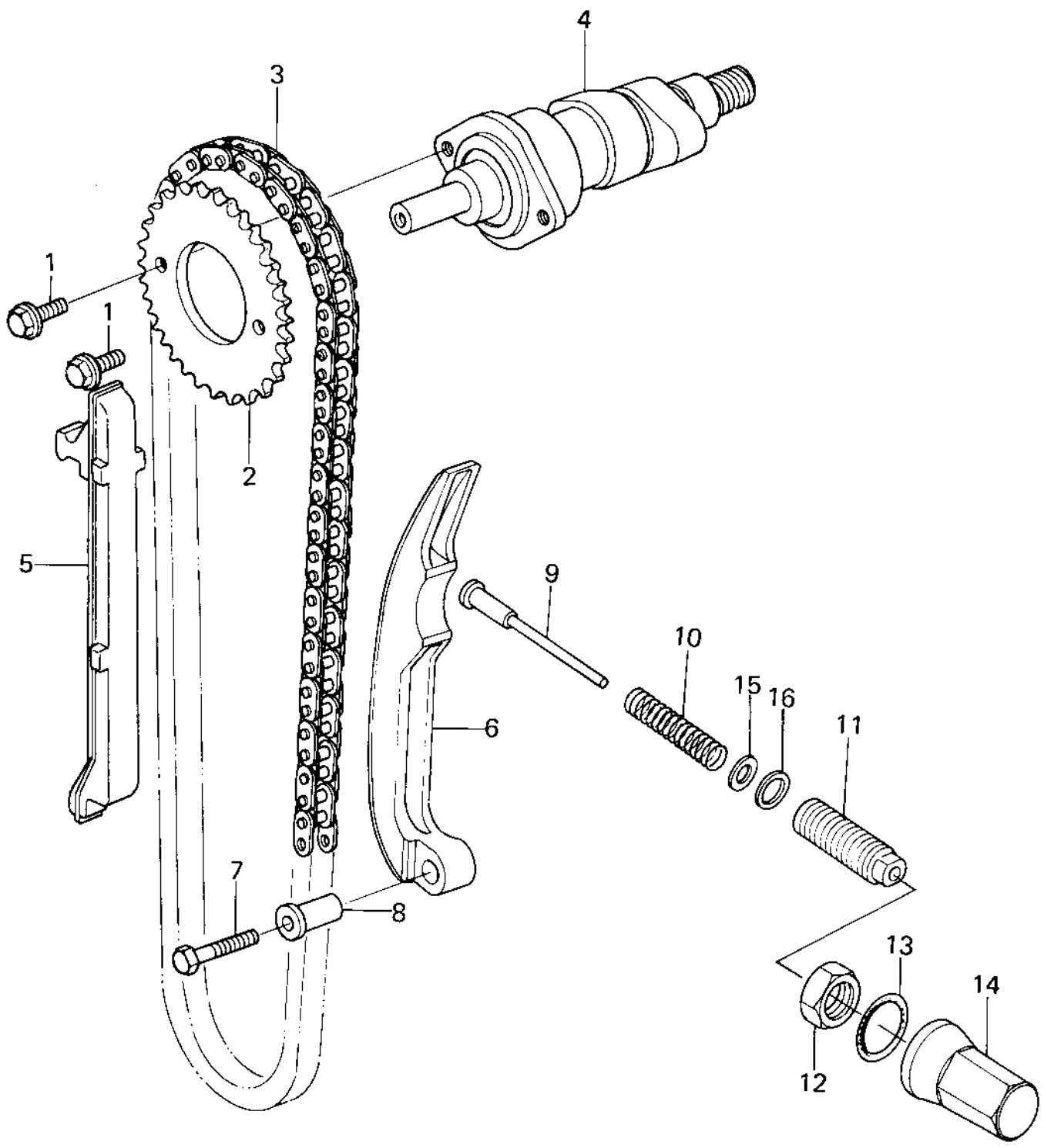

1979 KLR250 PARTS LIST

CAMSHAFT/CHAIN/TENSIONER

ITEM NAME	PART NUMBER	QUANTITY
BOLT,SPROCKET FITTING (Ref # 1)	92003-208	2
SPROCKET,CAM SHAFT (Ref # 2)	12046-1007	1
SPROCKET,CAM SHAFT (Ref # 2)	12046-1007	1
CHAIN,CAM (Ref # 3)	21070-013	1
SHAFT,CAM (Ref # 4)	12044-1040	1
SLIPER,CAM CHAIN (Ref # 5)	12053-023	1
SLIPER,CAM CHAIN (Ref # 6)	12053-024	1
BOLT-UPSET (Ref # 7)	112G0630	1
COLLAR (Ref # 8)	92027-155	1
ROD,PUSH (Ref # 9)	13116-1003	1
SPRING,CHAIN TENSINR (Ref # 10)	92081-131	1
GUIDE,PUSH ROD (Ref # 11)	92001-1271	1
NUT,LOCK (Ref # 12)	92016-054	1
"O" RING,22MM (Ref # 13)	92055-018	1
CAP,CAM CHAIN TENSION (Ref # 14)	12064-005	1
WASHER,PLAIN (Ref # 15)	92022-1029	1
WASHER,PLAIN (Ref # 16)	92022-1030	1