

1979 KLR250 PARTS DIAGRAM

ROCKER ARMS/VALVES ('78-'79 KL250-A1/A1A)

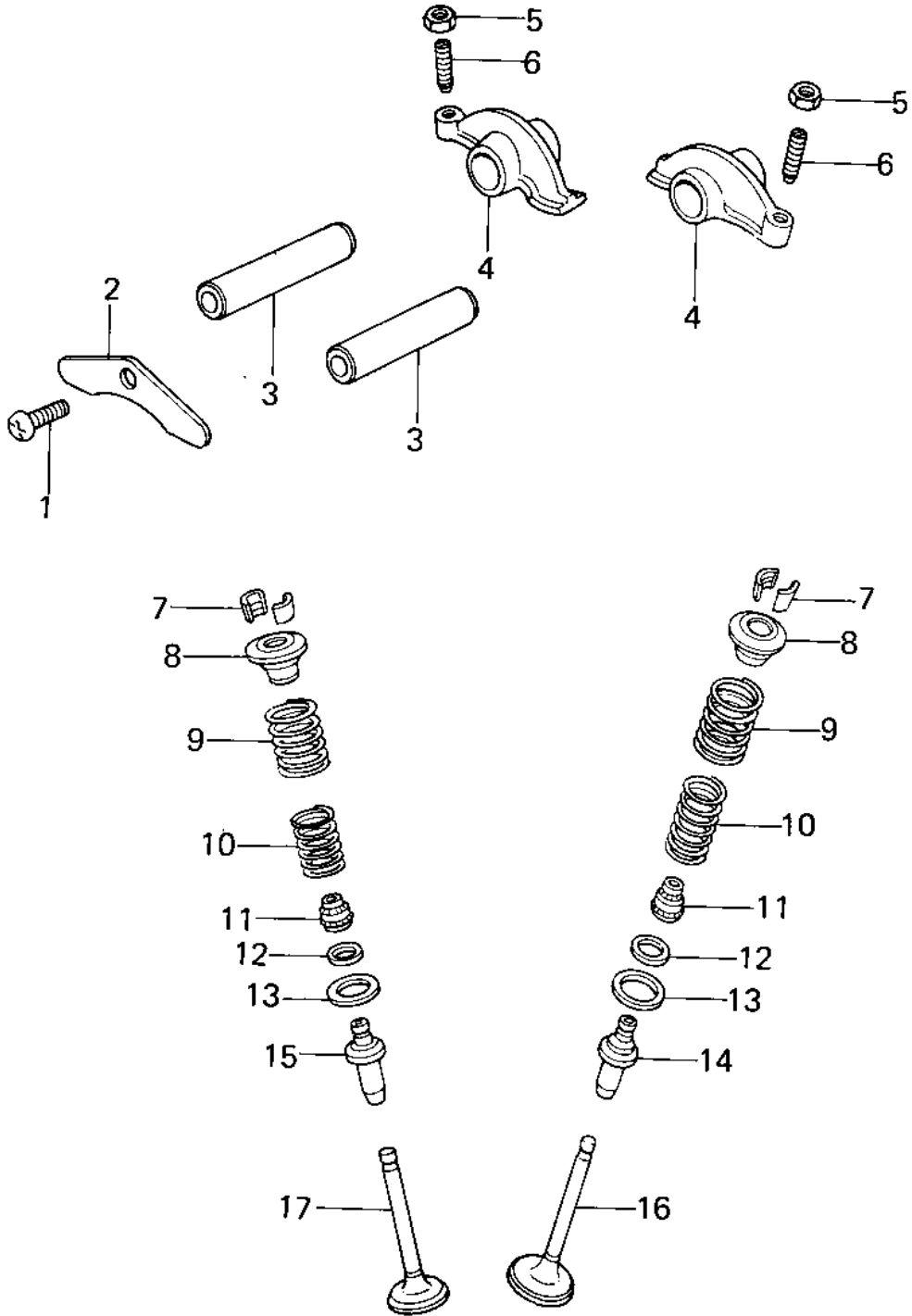

1979 KLR250 PARTS LIST

ROCKER ARMS/VALVES ('78-'79 KL250-A1/A1A)

ITEM NAME	PART NUMBER	QUANTITY
SCREW PAN HEAD 6X14 (Ref # 1)	220B0614	1
PLATE,POSITIONING (Ref # 2)	14014-034	1
SHAFT,ROCKER ARM (Ref # 3)	12020-004	2
ARM,ROCKER (Ref # 4)	12016-012	2
NUT,ROCKER ARM FITTNG (Ref # 5)	92016-061	2
SCREW,SLOTTED,ROCKER (Ref # 6)	92013-009	2
SPLIT KEEPER (Ref # 7)	12011-004	4
RETAINER,VALVE SPRING (Ref # 8)	12009-006	2
SPRING,OUTER VALVE (Ref # 9)	12007-013	2
SPRING,INNER VALVE (Ref # 10)	12007-014	2
OIL SEAL,RV37129.5 (Ref # 11)	92049-016	2
SEAT,VLV INNER SPRING (Ref # 12)	12010-006	2
SEAT,VLV OUTER SPRING (Ref # 13)	12010-005	2
GUIDE,INLET VALVE (Ref # 14)	12013-003	1
GUIDE,EXHAUST VALVE (Ref # 15)	49002-1010	1
VALVE,INLET (Ref # 16)	12004-018	1
VALVE,EXHAUST (Ref # 17)	12005-010	1