

1992 650 SX PARTS DIAGRAM

Jet Pump

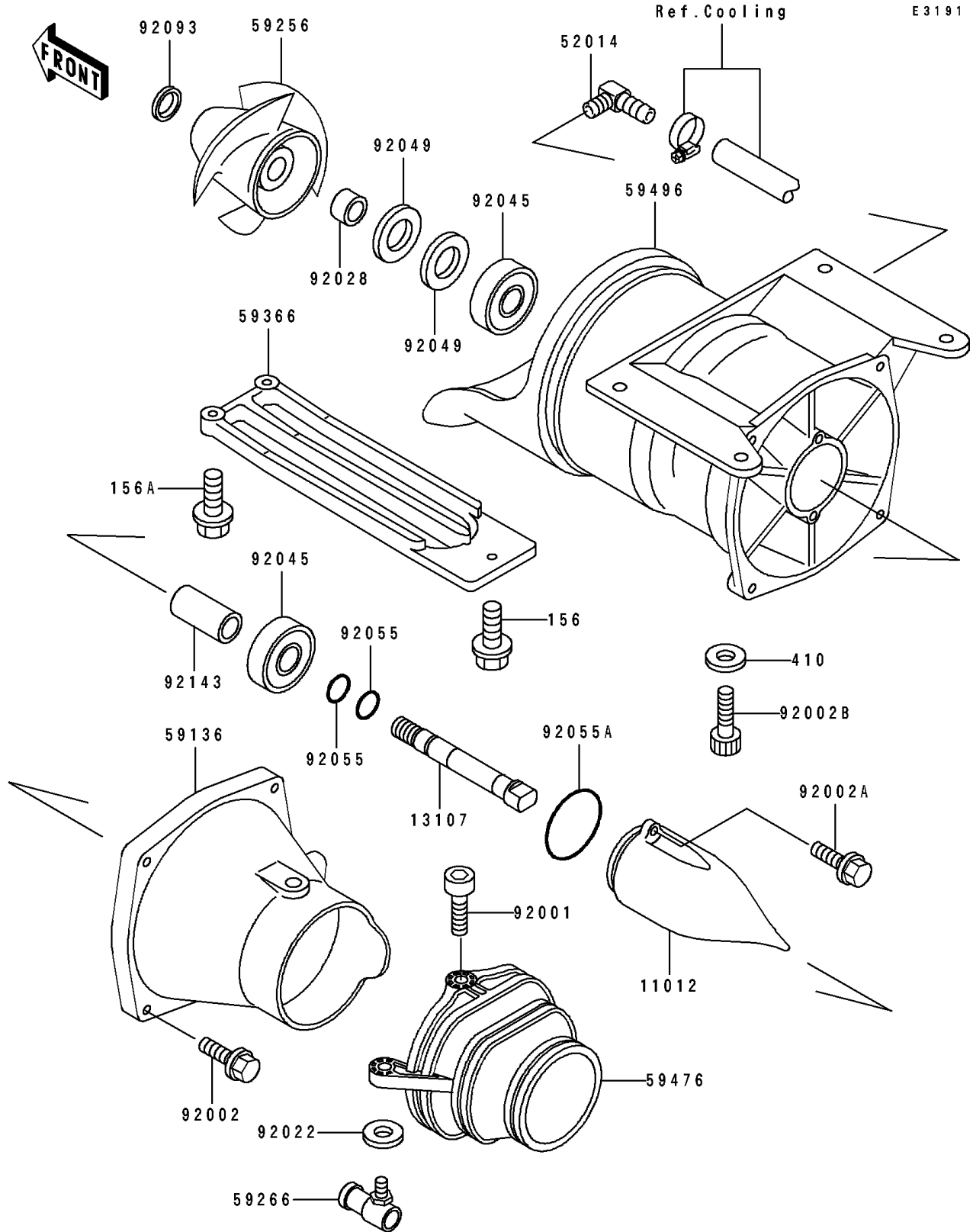

1992 650 SX PARTS LIST

Jet Pump

ITEM NAME	PART NUMBER	QUANTITY
CAP,JET PUMP (Ref # 11012)	11012-3712	1
SHAFT,JET PUMP (Ref # 13107)	13107-3721	1
ELBOW (Ref # 52014)	52014-3002	1
NOZZLE-PUMP (Ref # 59136)	59136-3710	1
IMPELLER (Ref # 59256)	59256-3705	1
JOINT-BALL (Ref # 59266)	59266-3701	1
GRATE (Ref # 59366)	59366-3702	1
NOZZLE-STRG (Ref # 59476)	59476-3711	1
VANE-GUIDE (Ref # 59496)	59496-3701	1
BOLT,SOCKET,6X11 (Ref # 92001)	92001-3701	2
BOLT,6X30 (Ref # 92002)	92002-3726	4
BOLT,6X16 (Ref # 92002A)	92002-3728	2
BOLT,SOCKET,8X20 (Ref # 92002B)	92002-3771	4
WASHER (Ref # 92022)	92022-567	1
BUSHING,17X25X15 (Ref # 92028)	92028-3717	1
BEARING-BALL,#63032RD (Ref # 92045)	92045-3706	2
SEAL-OIL,TCV-25476 (Ref # 92049)	92049-3711	2
RING-O,13X1.9 (Ref # 92055)	92055-1021	2
RING-O (Ref # 92055A)	92055-3706	1
SEAL (Ref # 92093)	92093-3702	1
COLLAR,17.4X25.4X53 (Ref # 92143)	92143-3708	1
BOLT-WP,6X12 (Ref # 156)	156R0612	1
BOLT-WP,6X25 (Ref # 156A)	156R0625	2
WASHER-PLAIN-SMALL,8MM (Ref # 410)	410S0800	4