

1979 KZ200-A2 PARTS DIAGRAM

GENERATOR/STARTER MOTOR

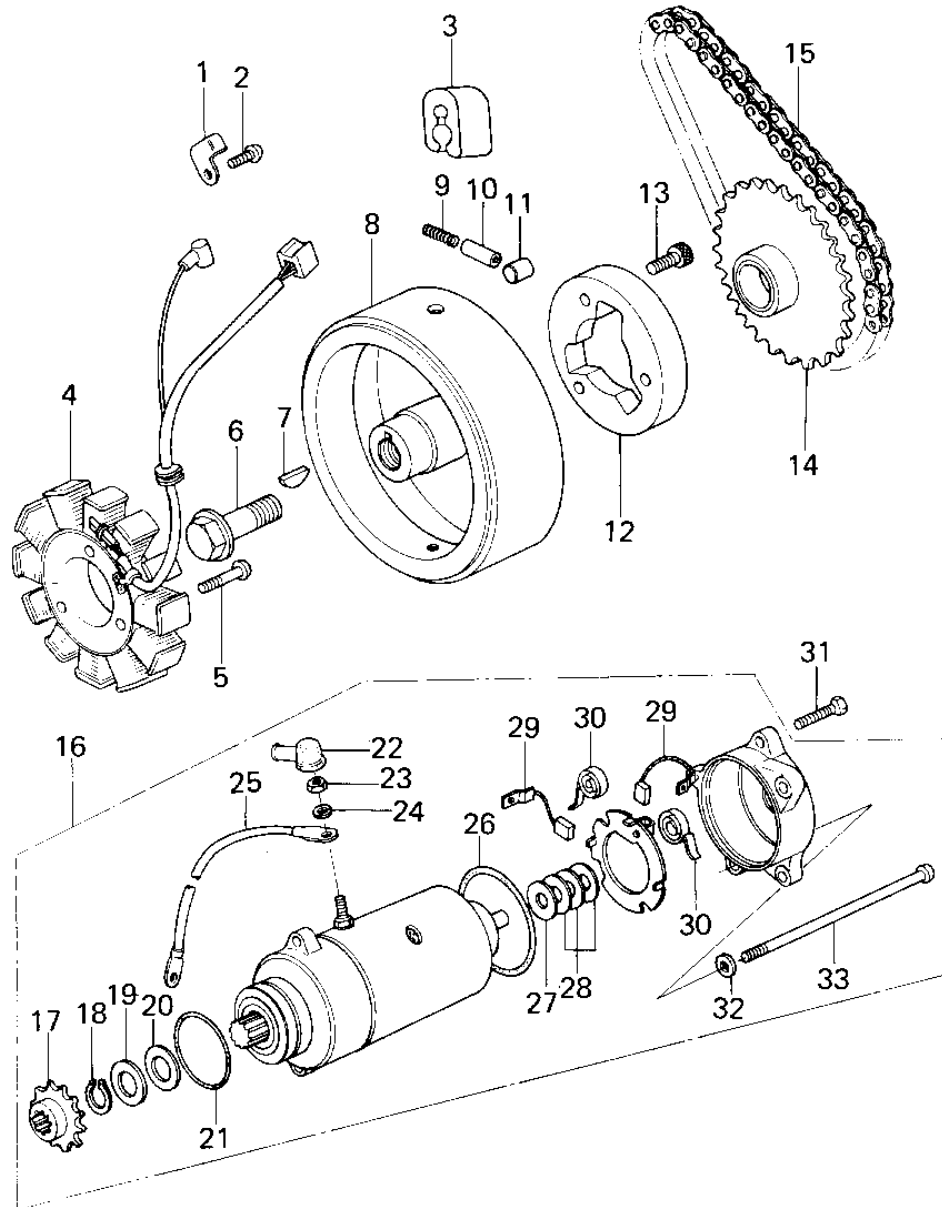

1979 KZ200-A2 PARTS LIST

GENERATOR/STARTER MOTOR

ITEM NAME	PART NUMBER	QUANTITY
CLAMP (Ref # 1)	92037-194	1
SCREW PAN HEAD 6X14 (Ref # 2)	220B0614	1
CLAMP,CABLE (Ref # 3)	92037-1049	2
STATOR ASSY (Ref # 4)	21003-1002	1
SCREW PAN HEAD 6X25 (Ref # 5)	220B0625	1
BOLT,10X40 (Ref # 6)	92001-1201	1
WOODRUFF KEY (Ref # 7)	92038-001	1
ROTOR (Ref # 8)	21007-1010	3
SPRING,COIL (Ref # 9)	92081-159	1
PIN (Ref # 10)	92043-132	1
ROLLER (Ref # 11)	92122-006	1
CLUTCH,STARTER (Ref # 12)	13194-008	1
BOLT (Ref # 13)	120P0816	1
SPROCKET,STARTER CLUT (Ref # 14)	12046-1107	1
CHAIN,DYNAMO (Ref # 15)	92057-1009	1
STARTER-ELECTRIC (Ref # 16)	21163-1036	1
SPROCKET,STARTER MOTO (Ref # 17)	12046-1004	1
CIRCLIP,13M/M (Ref # 18)	92033-037	1
WASHER,PLAIN,14MM (Ref # 19)	21025-008	1
WASHER PLAIN 14MM (Ref # 20)	21025-009	1
"O" RING,42.8MM (Ref # 21)	21027-005	1
CAP,STARTING MOTOR (Ref # 22)	21017-020	1
NUT 6MM (Ref # 23)	312B0600	1
WASHER SPRING 6MM (Ref # 24)	461F0600	2
WIRE-LEAD,STARTER MOT (Ref # 25)	26011-1201	1
"O" RING,62MM (Ref # 26)	21027-006	1
WASHER,THRUST,1.6T (Ref # 27)	21025-010	1
WASHER,THRUST,0.2T (Ref # 28)	21025-011	1
BRUSH CARBON (Ref # 29)	21039-004	1

1979 KZ200-A2 PARTS LIST

GENERATOR/STARTER MOTOR

ITEM NAME	PART NUMBER	QUANTITY
SPRING CARBON BRUSH (Ref # 30)	21040-004	1
BOLT,FLANGED,6X25 (Ref # 31)	130G0625	1
SCREW,PAN HEAD,6X130 (Ref # 33)	92001-1046	1