

1979 KZ200-A2 PARTS DIAGRAM

GEAR CHANGE MECHANISM

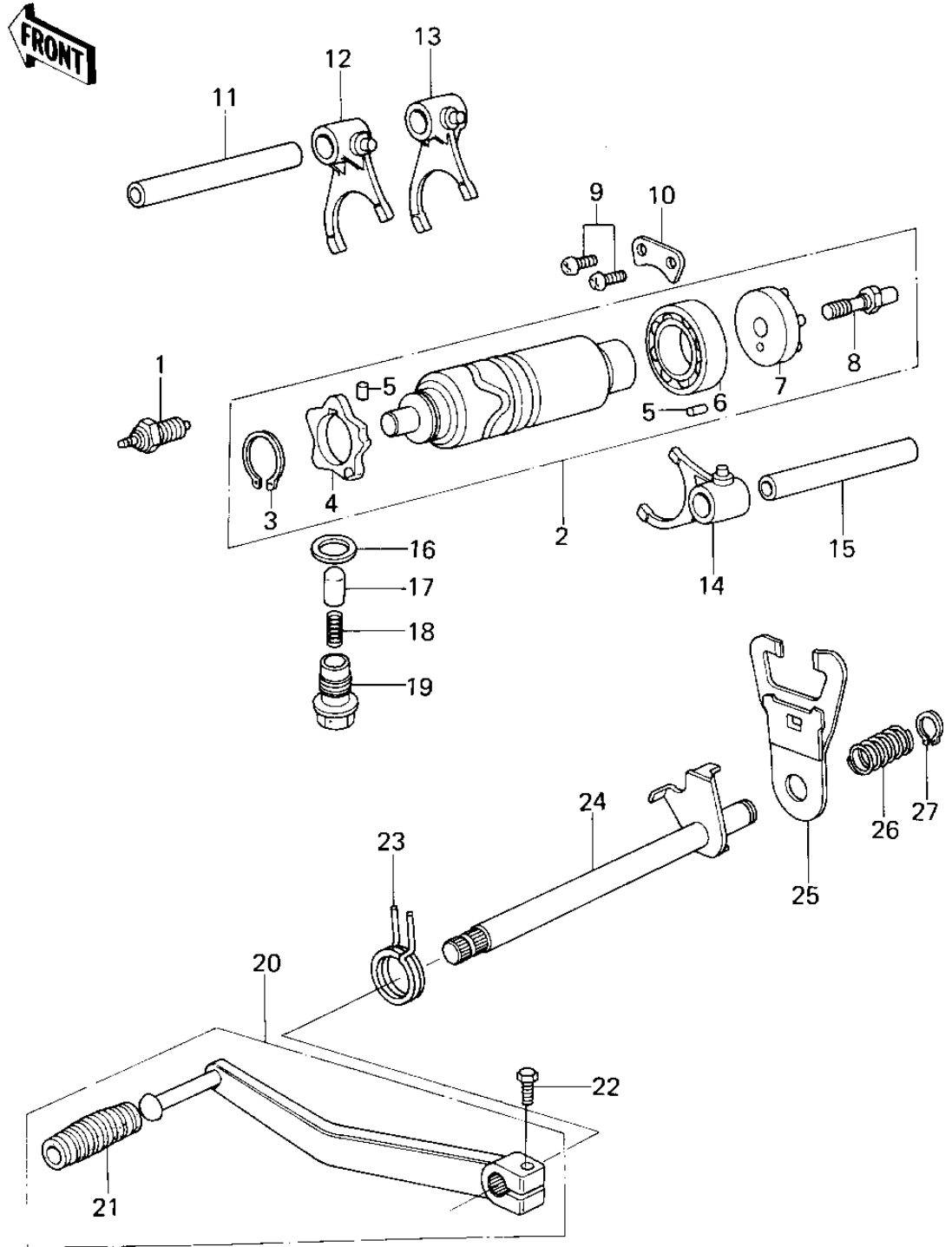

1979 KZ200-A2 PARTS LIST

GEAR CHANGE MECHANISM

ITEM NAME	PART NUMBER	QUANTITY
SWITCH,NEUTRAL (Ref # 1)	13151-5002	1
DRUM ASSY,GEAR SHIFT (Ref # 2)	13239-1036	1
CIRCLIP 24MM (Ref # 3)	480J2400	1
DISC,CHANGE DRUM (Ref # 4)	13145-007	1
PIN-DOWEL,4X6 (Ref # 5)	610A0406	1
BEARING,BALL,#6905 (Ref # 6)	92045-036	1
PLATE,GEAR CHANGE (Ref # 7)	13142-019	1
BOLT (Ref # 8)	92001-166	1
SCREW PAN HEAD 6X14 (Ref # 9)	220B0614	1
PLATE,GEAR CHANGE (Ref # 10)	13169-014	1
ROD,SHIFT 93.7M/M (Ref # 11)	49047-1003	1
SHIFT FORK,2ND&3RD (Ref # 12)	13140-074	1
SHIFT FORK,LOW (Ref # 13)	13140-073	1
SHIFT FORK,4TH&TOP (Ref # 14)	13140-075	1
ROD,SHIFT 71.7M/M (Ref # 15)	49047-1002	1
WASHER,PLAIN (Ref # 16)	92022-324	1
PIN,NEUTRAL POSITIONING (Ref # 17)	92043-131	1
SPRING (Ref # 18)	92081-112	1
BOLT,NEUTRAL POSITION (Ref # 19)	92001-182	1
PEDAL ASSY,GEAR CHANG (Ref # 20)	13242-020	1
DAMPER,CHANGE PEDAL (Ref # 21)	92160-1036	1
BOLT-UPSET,6X20 (Ref # 22)	112G0620	1
SPRING,CHG PEDL RTRN (Ref # 23)	92083-028	1
LEVER ASSY,GEAR SHIFT (Ref # 24)	13161-1013	1
LEVER ASSY,GEAR SHIFT (Ref # 25)	13161-044	1
SPRING,COIL (Ref # 26)	92081-149	1
CIRCLIP,13MM (Ref # 27)	480J1300	1