

1979 KZ200-A2 PARTS DIAGRAM

CLUTCH

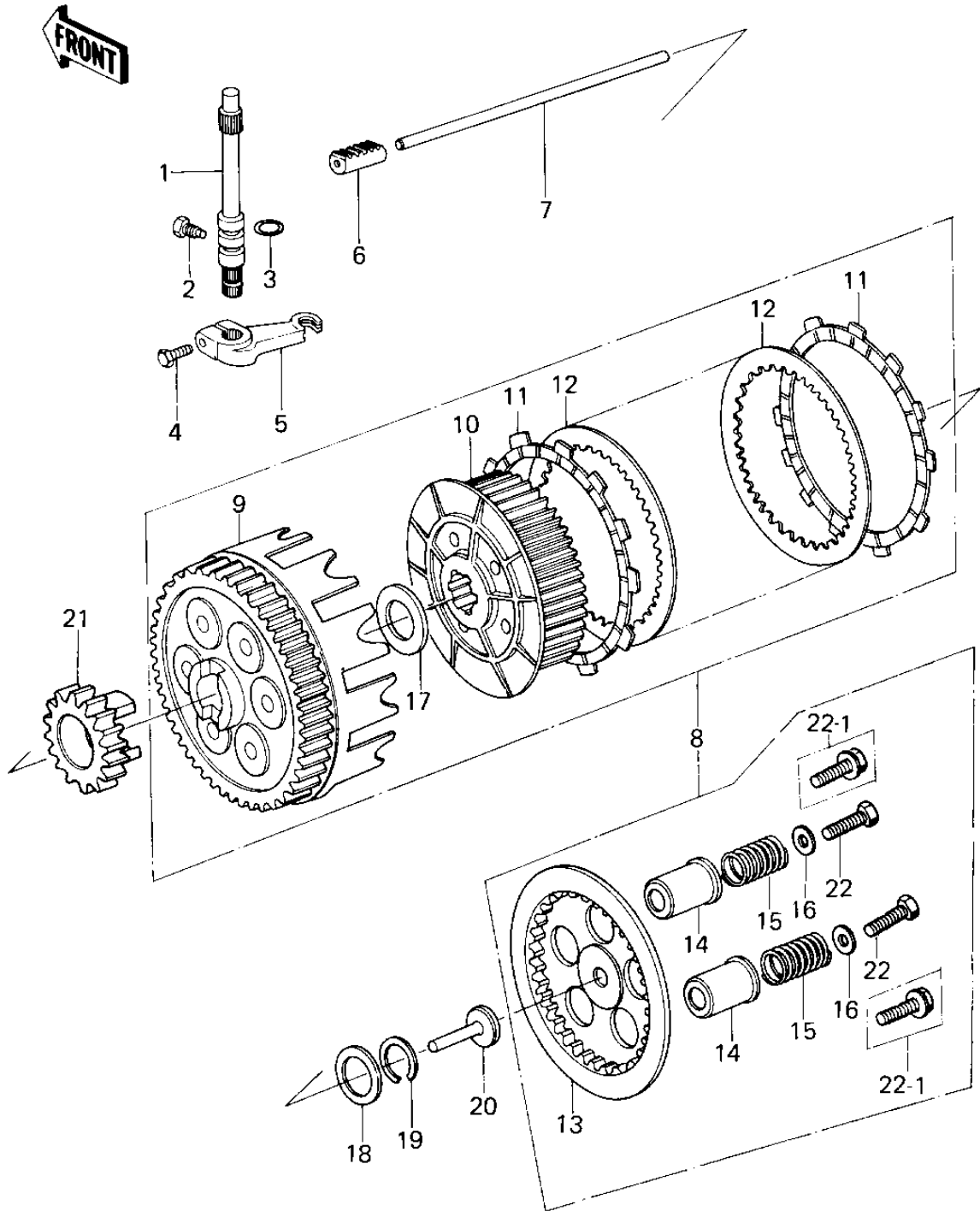

1979 KZ200-A2 PARTS LIST

CLUTCH

ITEM NAME	PART NUMBER	QUANTITY
SHAFT,CLUTCH RELEASE (Ref # 1)	13106-006	1
BOLT,CLUTCH RELEASE (Ref # 2)	92003-130	1
"O" RING, 10MM (Ref # 3)	670B2010	1
BOLT-UPSET (Ref # 4)	112G0618	2
LEVER,CLUTCH RELEASE (Ref # 5)	13103-028	1
ROD,CLUTCH PUSH (Ref # 6)	13116-1040	1
ROD,PUSH (Ref # 7)	13116-032	1
ROD,CLUTCH PUSH,LONG (Ref # 7)	13116-1002	1
CLUTCH-ASSY (Ref # 8)	13081-083	1
CLUTCH-ASSY (Ref # 8)	13081-1051	1
HOUSING,CLUTCH (Ref # 9)	13095-1006	2
HUB,CLUTCH (Ref # 10)	13087-045	1
HUB,CLUTCH (Ref # 10)	13087-1001	1
PLATE CLUTCH FRICTION (Ref # 11)	13088-015	2
PLATE CLUTCH STEEL (Ref # 12)	13089-013	2
PLATE-CLUTCH SPRING (Ref # 13)	13187-005	1
GUIDE CLUTCH SPRING (Ref # 14)	13092-005	1
SPRING-CLUTCH (Ref # 15)	92081-083	2
HOLDER,CLUTCH SPRING (Ref # 16)	13091-011	1
WASHER,PLAIN (Ref # 17)	92022-321	1
WASHER, PLAIN (Ref # 18)	92022-112	1
CIRCLIP,18MM (Ref # 19)	92033-029	1
PUSHER-CLTCH SPRG PLT (Ref # 20)	13116-016	1
PINION,KICKSTARTER (Ref # 21)	13075-012	1
BOLT,CLUTCH SPR FITT (Ref # 22-1)	92001-1066	1