

1979 KZ200-A2 PARTS DIAGRAM

CYLINDER HEAD/CYLINDER

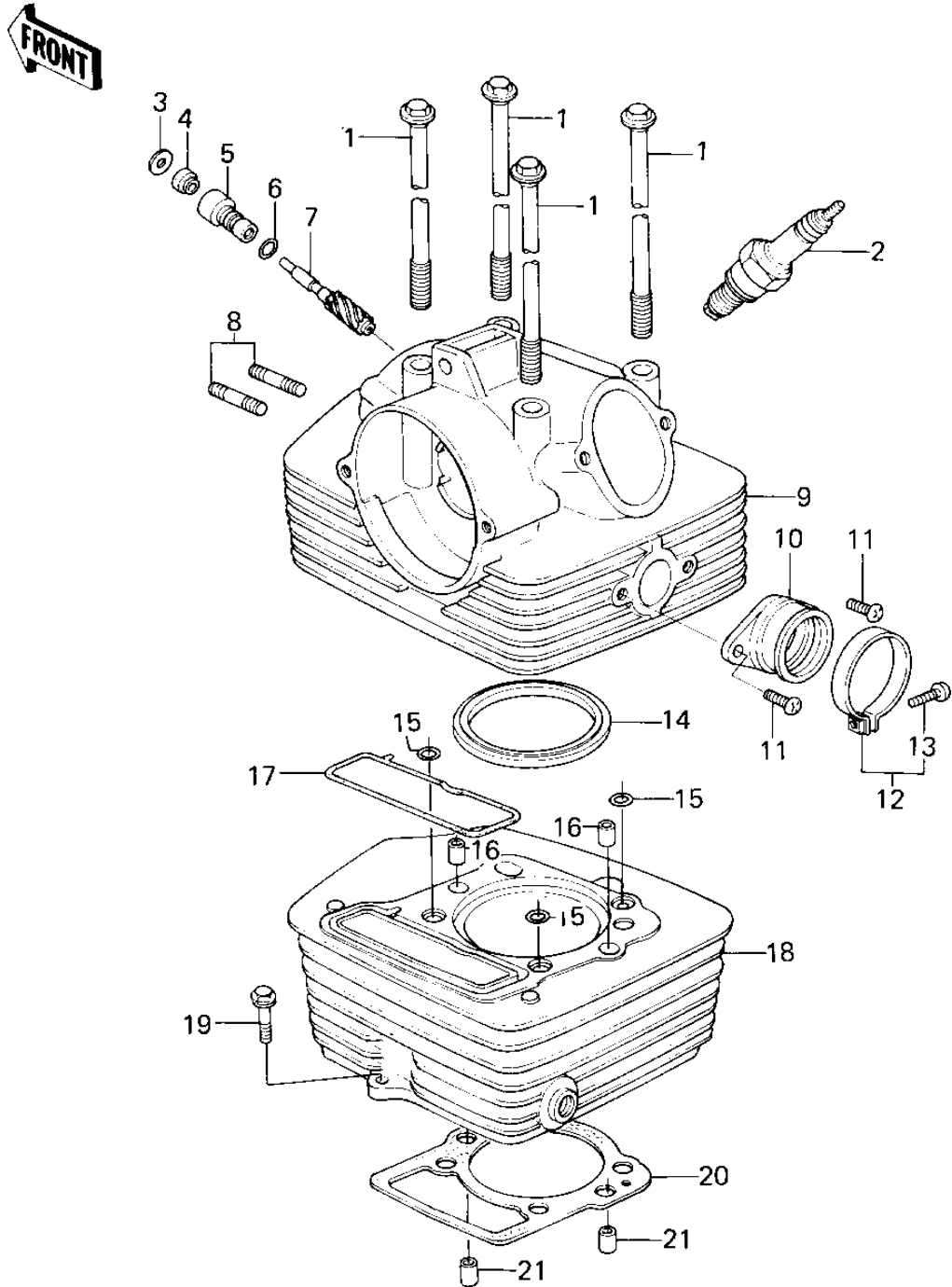

1979 KZ200-A2 PARTS LIST

CYLINDER HEAD/CYLINDER

ITEM NAME	PART NUMBER	QUANTITY
BOLT,8X233 (Ref # 1)	92003-220	1
SPARK PLUG B7ES (Ref # 2)	B7ES	1
GASKET,TACHO GEAR (Ref # 3)	92065-104	1
OIL SEAL (Ref # 4)	92050-075	1
GUIDE,TACHOMETER GEAR (Ref # 5)	92087-011	1
RING-O,10MM (Ref # 6)	92055-1149	2
GEAR,TACHOMETER (Ref # 7)	13223-012	1
STUD,6X27 (Ref # 8)	92004-066	1
HEAD ASSY,CYLINDER (Ref # 9)	11002-5014	1
HOLDER,CARBURETOR (Ref # 10)	16065-045	1
SCREW PAN HEAD 6X14 (Ref # 11)	220B0614	1
CLAMP, CARBURETOR HOLDER (Ref # 12)	92037-178	1
SCREW-PAN-CROS,5X25 (Ref # 13)	220B0525	1
GASKET,CYLINDER HEAD (Ref # 14)	11004-1004	1
PIN,DOWEL,10X8.2X14 (Ref # 16)	92043-1037	2
"O" RING (Ref # 17)	92055-105	1
CYLINDER (Ref # 18)	11005-153	1
BOLT (Ref # 19)	92003-202	1
GASKET,CYLINDER BASE (Ref # 20)	11009-043	1