

1982 KLT200 PARTS DIAGRAM

CHAIN CASE (KLT200-A1)

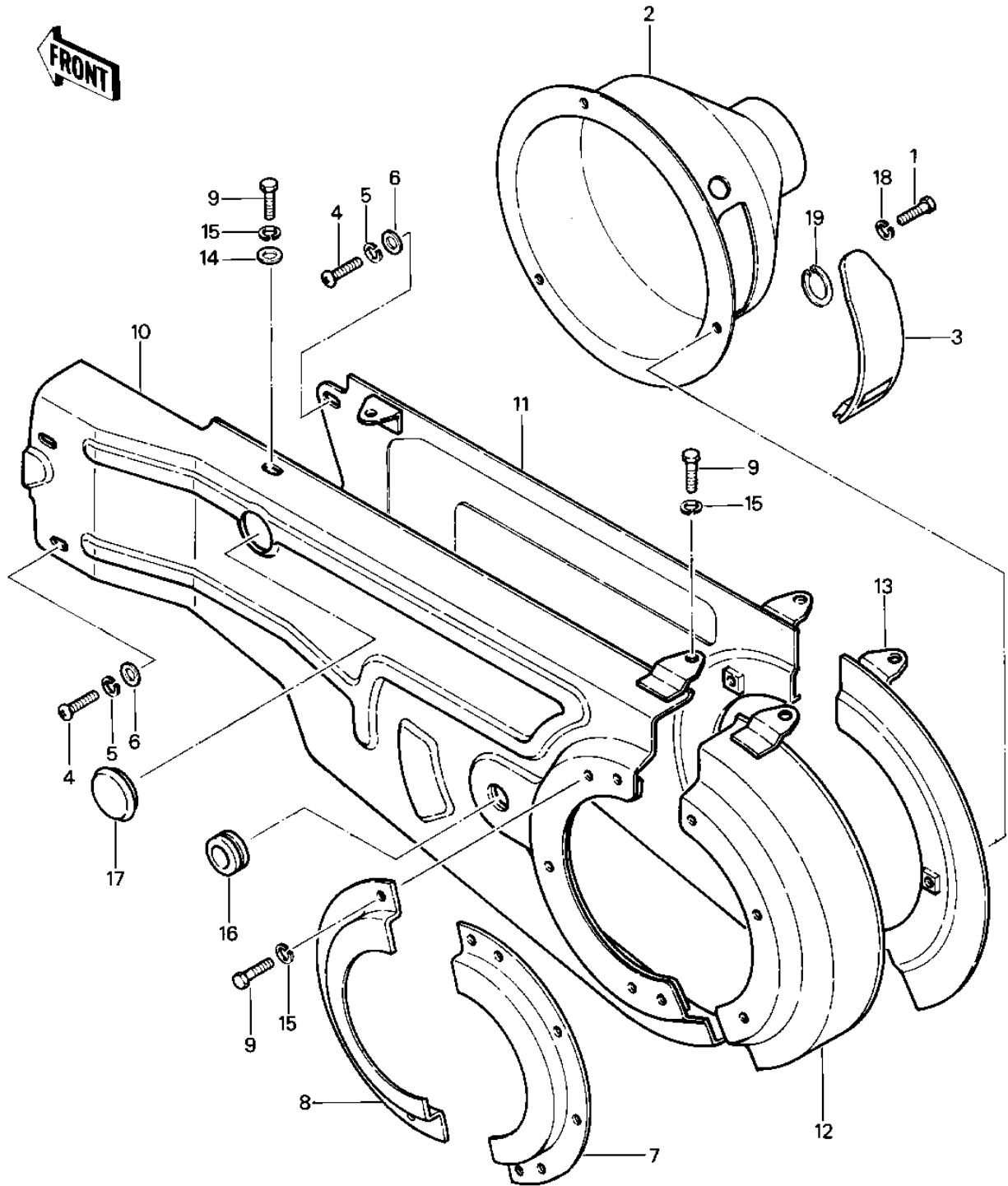

1982 KLT200 PARTS LIST

CHAIN CASE (KLT200-A1)

ITEM NAME	PART NUMBER	QUANTITY
BOLT-UPSET,6X12 (Ref # 1)	112G0612	3
COVER,DIFFERENTIAL (Ref # 2)	14025-4009	1
COVER,DIFFERENTIAL (Ref # 3)	14025-4010	1
SCREW PAN HEAD 6X12 (Ref # 4)	220B0612	4
WASHER SPRING 6MM (Ref # 5)	461F0600	4
WASHER PLAIN 6MM (Ref # 6)	410B0600	4
BRKT,CHAIN CASE,RR (Ref # 7)	11034-4055	1
BRKT,CHAIN CASE,FR (Ref # 8)	11034-4065	1
BOLT-UPSET,6X12 (Ref # 9)	112G0612	14
CASE-CHAIN,OUTSIDE (Ref # 10)	36014-4002	1
CASE-CHAIN,INNER (Ref # 11)	36014-1041	1
CASE-CHAIN,RR (Ref # 12)	36014-1059	1
UNAVAILABLE IN PRICE BOOK (Ref # 13)	36014-4006	1
WASHER PLAIN 6MM (Ref # 14)	410B0600	1
WASHER SPRING 6MM (Ref # 15)	461F0600	14
GROMMET HARNESS 22MM (Ref # 16)	92071-012	1
PLUG CHAIN CASE (Ref # 17)	92074-004	1
WASHER SPRING 6MM (Ref # 18)	461F0600	3
CIRCLIP, 20MM (Ref # 19)	480J2000	1