

1982 KLT200 PARTS DIAGRAM

KICKSTARTER MECHANISM

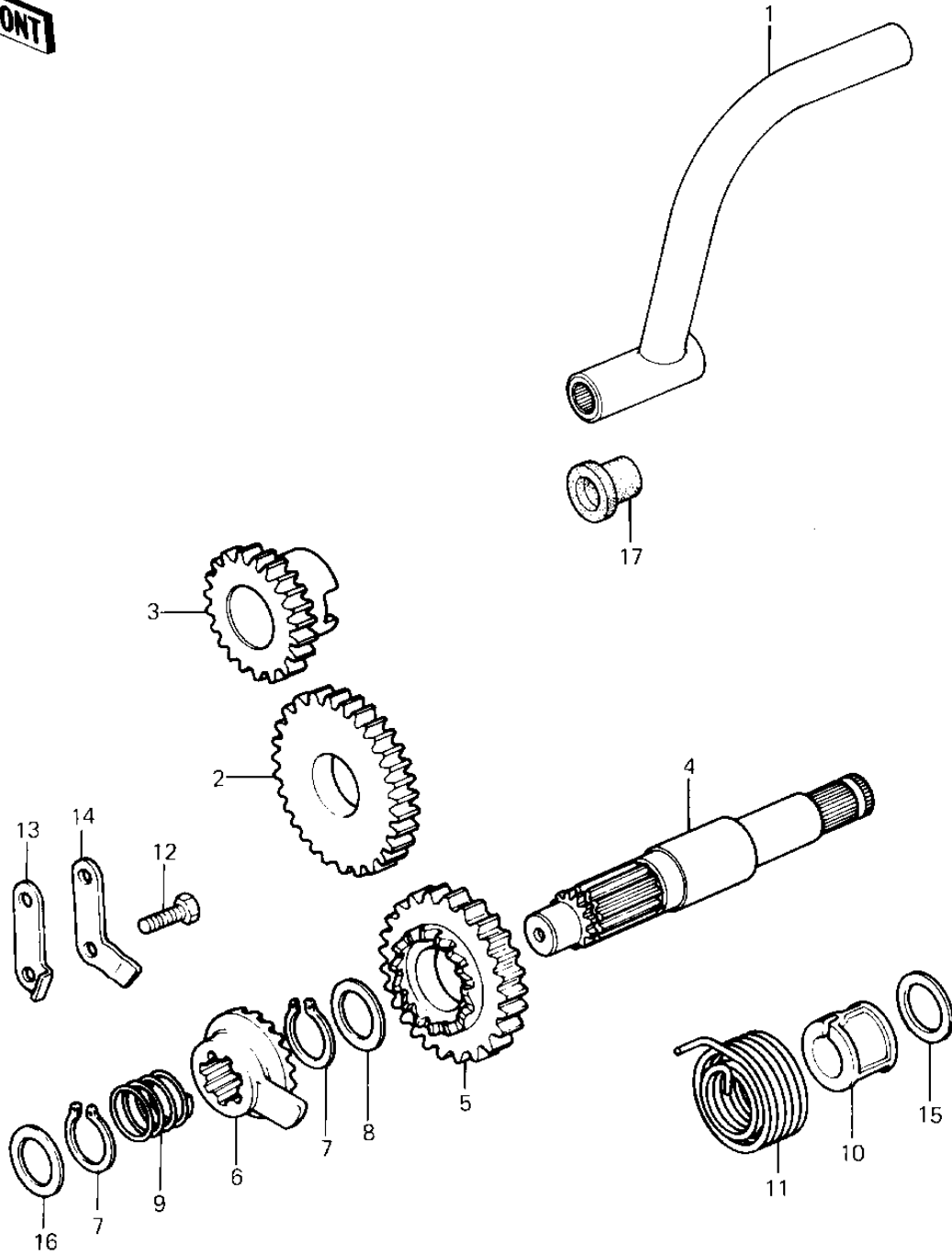

1982 KLT200 PARTS LIST

KICKSTARTER MECHANISM

ITEM NAME	PART NUMBER	QUANTITY
LEVER,KICK (Ref # 1)	13059-1013	1
IDLE GEAR,KICKSTARTER (Ref # 2)	13073-013	1
PINION,KICKSTARTER (Ref # 3)	13075-012	1
SHAFT,KICK (Ref # 4)	13066-1018	1
GEAR-COMP,KICKSTARTER (Ref # 5)	13216-1099	1
RATCHET,KL250-D2 (Ref # 6)	13078-1052	1
CIRCLIP 16MM (Ref # 7)	480J1600	2
WASHER,PLAIN (Ref # 8)	92022-315	1
SPRING,RATCHET (Ref # 9)	92081-122	1
GUID,KICKSTARTER SPRG (Ref # 10)	13070-011	1
SPRING-KICKSTARTER (Ref # 11)	92082-003	1
BOLT-UPSET (Ref # 12)	112G0618	2
STOPPER,KICKSTARTER (Ref # 13)	13072-017	1
GUIDE,KICK RATCHET (Ref # 14)	13206-1004	1
WASHER THRUST (Ref # 15)	92022-118	1
WASHER,PLAIN (Ref # 16)	92022-269	1
PLUG,KICK LEVER (Ref # 17)	92066-1067	1