

1982 KLT200 PARTS DIAGRAM

CLUTCH ('81-'82 KLT200-A1/A2/A3)

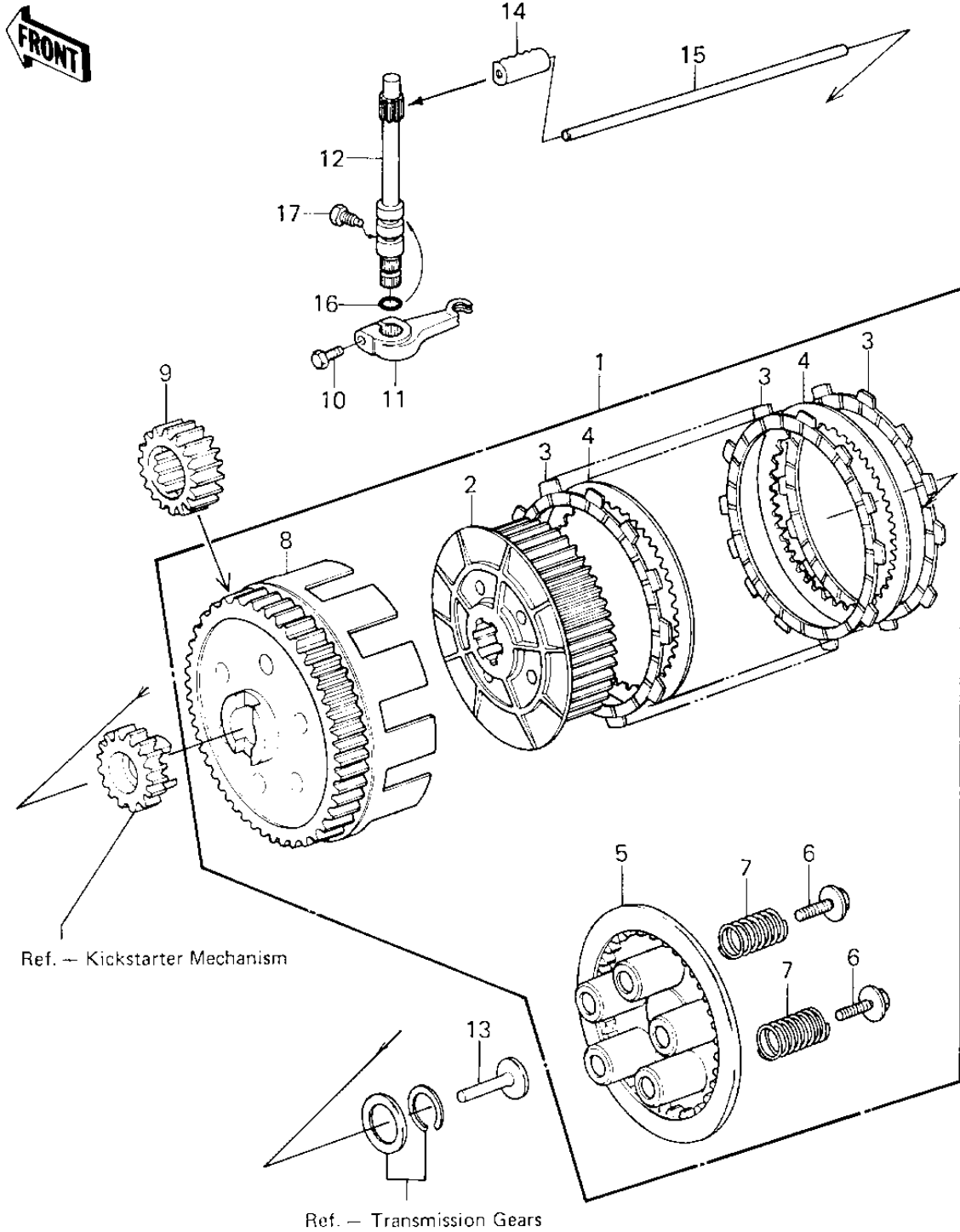

1982 KLT200 PARTS LIST

CLUTCH ('81-'82 KLT200-A1/A2/A3)

ITEM NAME	PART NUMBER	QUANTITY
CLUTCH-ASSY (Ref # 1)	13081-1052	1
HUB,CLUTCH (Ref # 2)	13087-1001	1
PLATE,CLUTCH FRICTION (Ref # 3)	13088-1008	7
PLATE CLUTCH STEEL (Ref # 4)	13089-013	6
PLATE,CLUTCH OPERATNG (Ref # 5)	13187-1005	1
BOLT,CLUTCH SPR FITT (Ref # 6)	92001-1066	5
SPRING-CLUTCH (Ref # 7)	92081-083	5
HOUSING-COMP-CLUTCH (Ref # 8)	13095-1032	1
GEAR-PRIMARY,19T (Ref # 9)	13097-1039	1
BOLT-UPSET (Ref # 10)	112G0618	1
LEVER,CLUTCH RELEASE (Ref # 11)	13103-028	1
SHAFT,CLUTCH RELEASE (Ref # 12)	13106-006	1
PUSHER-CLTCH SPRG PLT (Ref # 13)	13116-016	1
ROD,CLUTCH PUSH (Ref # 14)	13116-1040	1
ROD,CLUTCH PUSH,LONG (Ref # 15)	13116-1002	1
"O" RING, 10MM (Ref # 16)	670B2010	1
BOLT,CLUTCH RELEASE (Ref # 17)	92003-130	1