

1982 KLT200 PARTS DIAGRAM

ROCKER ARMS/VALVES ('81-'82 KLT200-A1/A2)

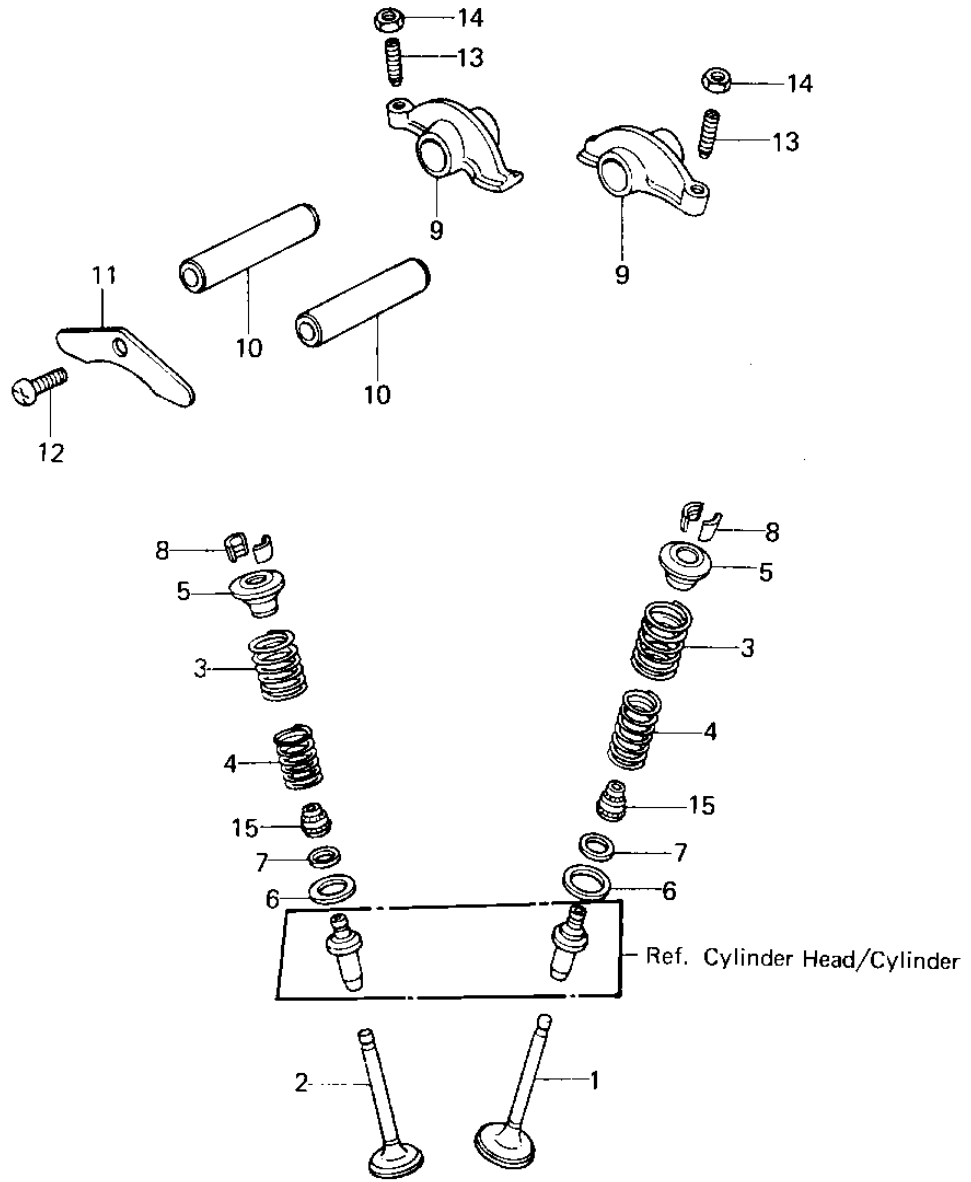

1982 KLT200 PARTS LIST

ROCKER ARMS/VALVES ('81-'82 KLT200-A1/A2)

ITEM NAME	PART NUMBER	QUANTITY
VALVE,INLET (Ref # 1)	12004-1006	1
VALVE,EXHAUST (Ref # 2)	12005-1005	1
SPRING,OUTER VALVE (Ref # 3)	12007-013	2
SPRING,INNER VALVE (Ref # 4)	12007-014	2
RETAINER,VALVE SPRING (Ref # 5)	12009-006	2
SEAT,VLV OUTER SPRING (Ref # 6)	12010-005	2
SEAT,VLV INNER SPRING (Ref # 7)	12010-006	2
SPLIT KEEPER (Ref # 8)	12011-004	4
ARM,ROCKER (Ref # 9)	12016-012	2
SHAFT,ROCKER ARM (Ref # 10)	12020-004	2
PLATE,POSITIONING (Ref # 11)	14014-034	1
SCREW PAN HEAD 6X14 (Ref # 12)	220B0614	1
SCREW,SLOTTED,ROCKER (Ref # 13)	92013-009	2
NUT,ROCKER ARM FITTNG (Ref # 14)	92016-061	2
OIL SEAL,RV37129.5 (Ref # 15)	92049-016	2