

1979 KD175-A4 PARTS DIAGRAM

KICKSTARTER MECHANISM

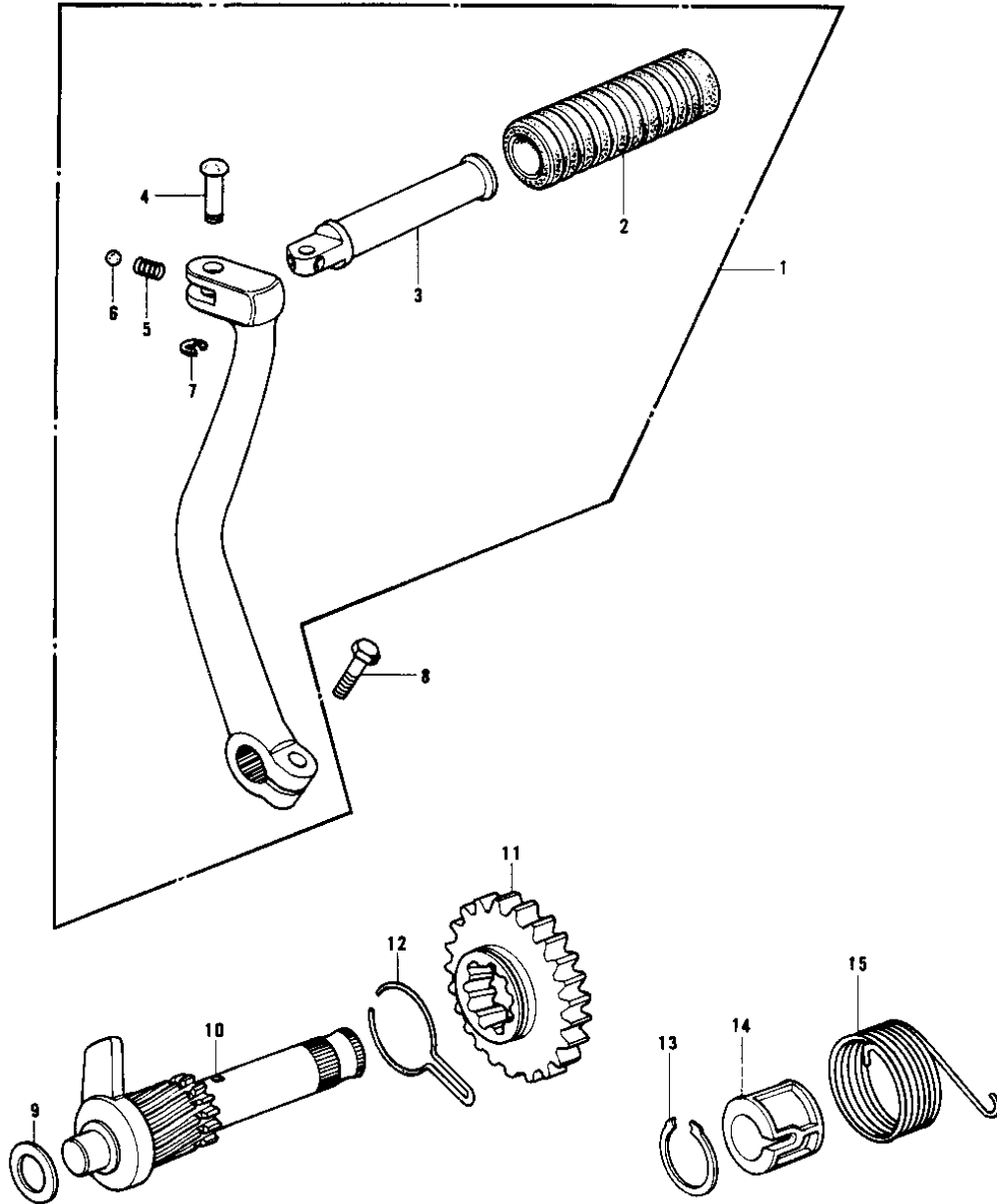

1979 KD175-A4 PARTS LIST

KICKSTARTER MECHANISM

ITEM NAME	PART NUMBER	QUANTITY
PEDAL ASSY,KICK (Ref # 1)	13064-020	
RUBBER KICK PEDAL (Ref # 2)	13063-002	
LEVER,KICK PEDAL (Ref # 3)	13060-003	
PIN-KICK PEDAL (Ref # 4)	92043-088	
SPRING-KICK STARTER (Ref # 5)	92081-049	
BALL-STEEL,11/32" (Ref # 6)	600A1100	
CIRCLIP 5MM (Ref # 7)	482K5000	
BOLT-SMALL-UPSET 8X25 (Ref # 8)	115G0825	
SHIM-KICK SHAFT,0.5T (Ref # 9)	92022-150	
SHAFT,KICK (Ref # 10)	13245-010	
GEAR-KICKSTARTER (Ref # 11)	13068-026	
HOLDER KICK GEAR (Ref # 12)	13077-002	
CIRCLIP (Ref # 13)	92033-022	
GUIDE,KICK SPRING (Ref # 14)	13070-010	
SPRING,KICKSTARTER (Ref # 15)	92082-005	