

# 1978 KD175-A3 PARTS DIAGRAM

## TRANSMISSION

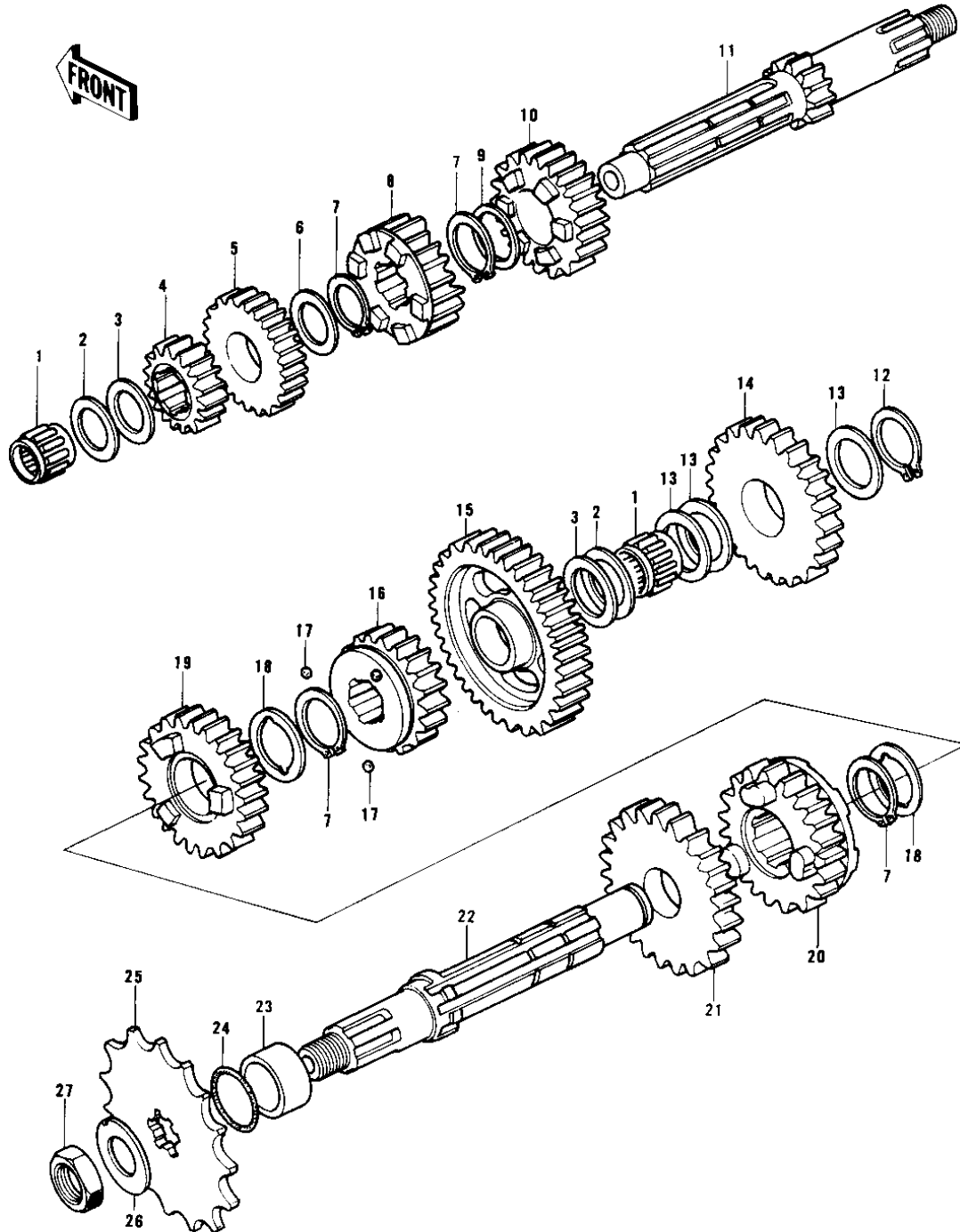

# 1978 KD175-A3 PARTS LIST

## TRANSMISSION

ITEM NAME	PART NUMBER	QUANTITY
BEARING-NEEDLE (Ref # 1)	92046-026	
WASHER-THRUST (Ref # 2)	92022-170	
WASHER-THRUST (Ref # 3)	92022-171	
2ND GEAR-DRIVE (Ref # 4)	13130-024	
4TH GEAR,DRIVE (Ref # 5)	13134-023	
WASHER-PLAIN (Ref # 6)	92022-181	
CIRCLIP,21MM (Ref # 7)	480J2100	
3RD GEAR-DRIVE (Ref # 8)	13132-022	
WASHER 22MM (Ref # 9)	92022-106	
TOP GEAR,DRIVE (Ref # 10)	13136-052	
SHAFT-DRIVE (Ref # 11)	13127-029	
CIRCLIP 15MM (Ref # 12)	480J1500	
WASHER-PLAIN (Ref # 13)	92022-169	
IDLE GEAR-KICKSTARTER (Ref # 14)	13073-009	
LOW GEAR,OUTPUT SHAFT (Ref # 15)	13129-051	
TOP GEAR,OUTER (Ref # 16)	13137-034	
BALL STEEL 5/32' (Ref # 17)	600A0500	
WASHER-LOCK (Ref # 18)	92024-031	
3RD GEAR-OUTPUT (Ref # 19)	13133-021	
4TH GEAR,OUTER (Ref # 20)	13135-029	
2ND GEAR-OUTPUT (Ref # 21)	13131-029	
SHAFT-OUTPUT (Ref # 22)	13128-028	
COLLAR-ENG SPROCKET (Ref # 23)	92027-180	
"0" RING (Ref # 24)	92055-022	
SPROCKET-OUTPUT,14T (Ref # 25)	13144-1058	
ENGINE SPROCKET,13T (Ref # 25)	13144-053	
ENGINE SPROCKET,1ST (Ref # 25)	13144-054	
WASHER LOCK 12MM (Ref # 26)	92024-002	
NUT,12MM (Ref # 27)	92016-024	