

1976 KE125 PARTS DIAGRAM

FOOTRESTS/STAND/BRAKE PEDAL ('76-'79)

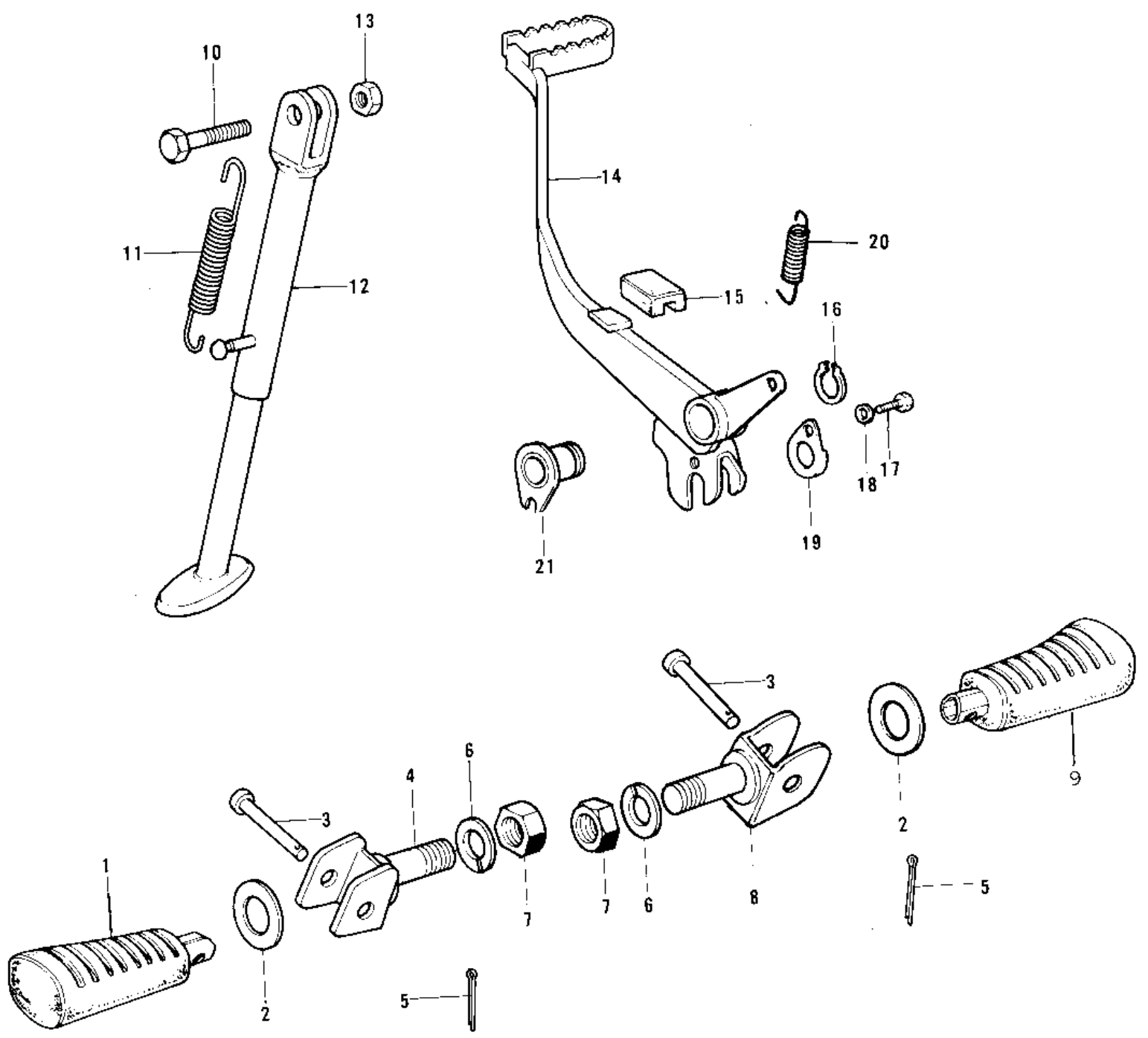

1976 KE125 PARTS LIST

FOOTRESTS/STAND/BRAKE PEDAL ('76-'79)

ITEM NAME	PART NUMBER	QUANTITY
STEP-ASSY,FR,LH (Ref # 1)	34027-1114	1
WASHER,PLAIN (Ref # 2)	92022-250	2
PIN-FOOTREST BAR FIT (Ref # 3)	92043-080	3
BRACKET,FOTRST BAR,LH (Ref # 4)	34003-051	1
PIN COTTER 2.5X16 (Ref # 5)	550D2516	2
WASHER SPRING 14MM (Ref # 6)	461F1400	2
NUT,14MM (Ref # 7)	314B1400	2
BRACKET,FOTRST BAR,RH (Ref # 8)	34003-052	1
STEP-ASSY,FR,RH (Ref # 9)	34027-1115	1
BOLT,HEX HEAD 10X35 (Ref # 10)	92001-1252	1
SPRING,SIDE STAND (Ref # 11)	34025-008	1
STAND-SIDE (Ref # 12)	34024-1043	1
NUT,10MM (Ref # 13)	314B1000	1
PEDAL,BRAKE (Ref # 14)	43001-058	1
DAMPER RUBBER,BK PDL (Ref # 15)	92075-220	1
CIRCLIP,22MM (Ref # 16)	480J2200	1
SCREW PAN HEAD 5X8 (Ref # 1)	220B0508	1
WASHER SPRING 5MM (Ref # 18)	461F0500	1
PLATE (Ref # 19)	43081-002	1
SPRING BRAKE PEDAL (Ref # 20)	43005-032	1
COLLAR,BRAKE PEDAL (Ref # 21)	92027-210	1