

1978 KM100-A3 PARTS DIAGRAM

GEAR CHANGE MECHANISM (KM100-A6/A7)

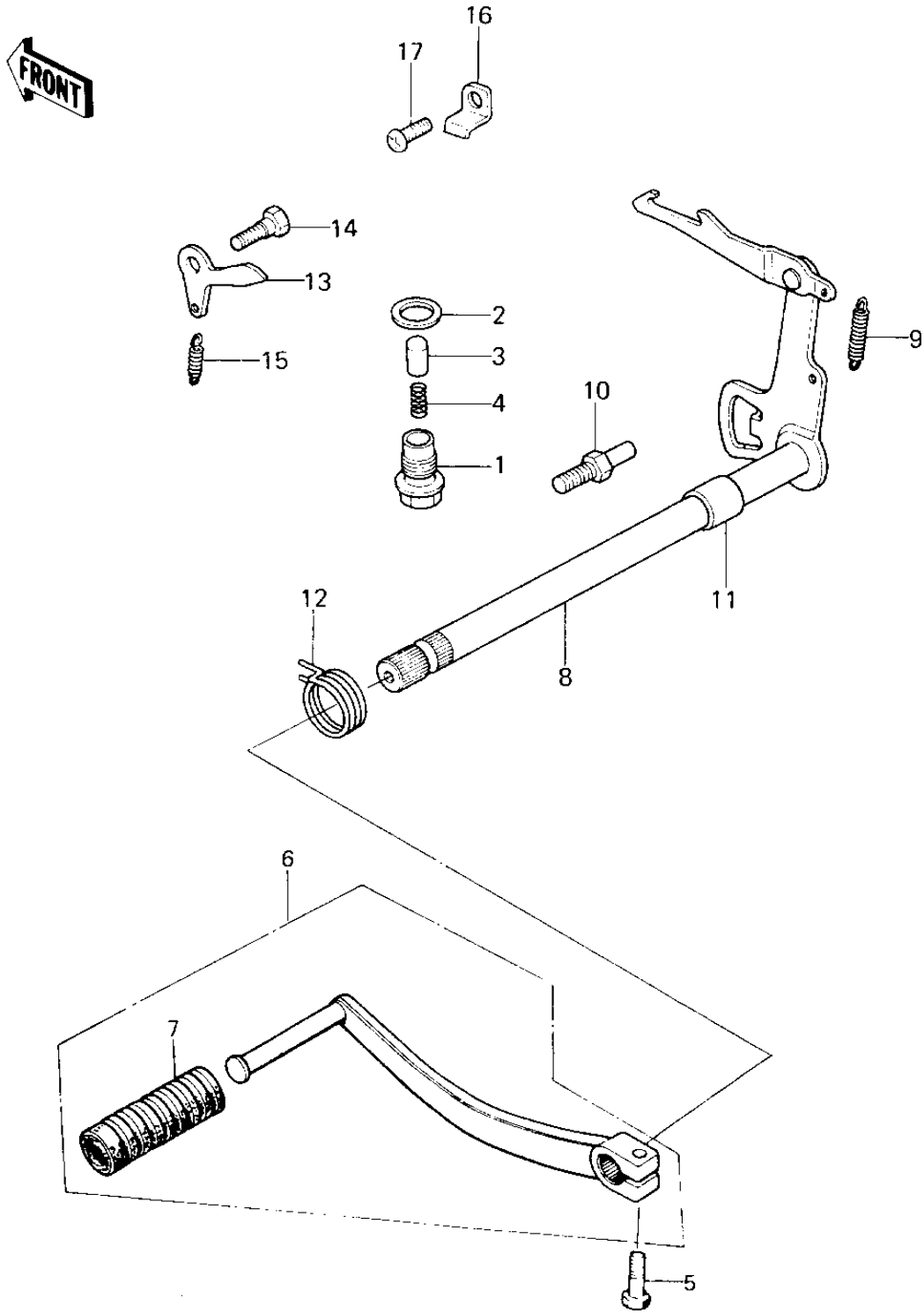

1978 KM100-A3 PARTS LIST

GEAR CHANGE MECHANISM (KM100-A6/A7)

ITEM NAME	PART NUMBER	QUANTITY
BOLT,NEUTRAL POSITION (Ref # 1)	92001-182	
WASHER,PLAIN (Ref # 2)	92022-324	
PIN,NEUTRAL POSITIONG (Ref # 3)	92043-131	
BALL,STEEL,13/32" (Ref # 3-1)	600A1300	
SPRING (Ref # 4)	92081-112	
BOLT-UPSET,6X20 (Ref # 5)	112G0620	
PEDAL SET GEAR CHANGE (Ref # 6)	13242-004	
RUBBER CHANGE PEDAL (Ref # 7)	13157-004	
LEVER-COMP CHANGE (Ref # 8)	13161-5001	
LEVER-COMP CHANGE (Ref # 8)	13161-5001	
SPRING,CHANGE LEVER (Ref # 9)	92144-1720	
BOLT,RETURN SPRING (Ref # 10)	92001-1401	
BOLT,RETURN SPRING (Ref # 10)	92001-1401	
COLLAR (Ref # 11)	92027-121	
SPRING,TENTION (Ref # 12)	92081-1129	
LEVER,GEAR CHANGE DRM (Ref # 13)	13168-1046	
BOLT,CHANGE DRUM LEVE (Ref # 14)	92150-1450	
SPRING,CHNG DRUM LEV (Ref # 15)	92083-012	
PLATE,GEAR CHANGE DRM (Ref # 16)	13169-1201	
PLATE,GEAR CHANGE (Ref # 16)	13169-1253	
SCREW PAN HEAD 6X12 (Ref # 17)	220B0612	