

# 1978 KM100-A3 PARTS DIAGRAM

TRANSMISSION (KM100-A6/A7)

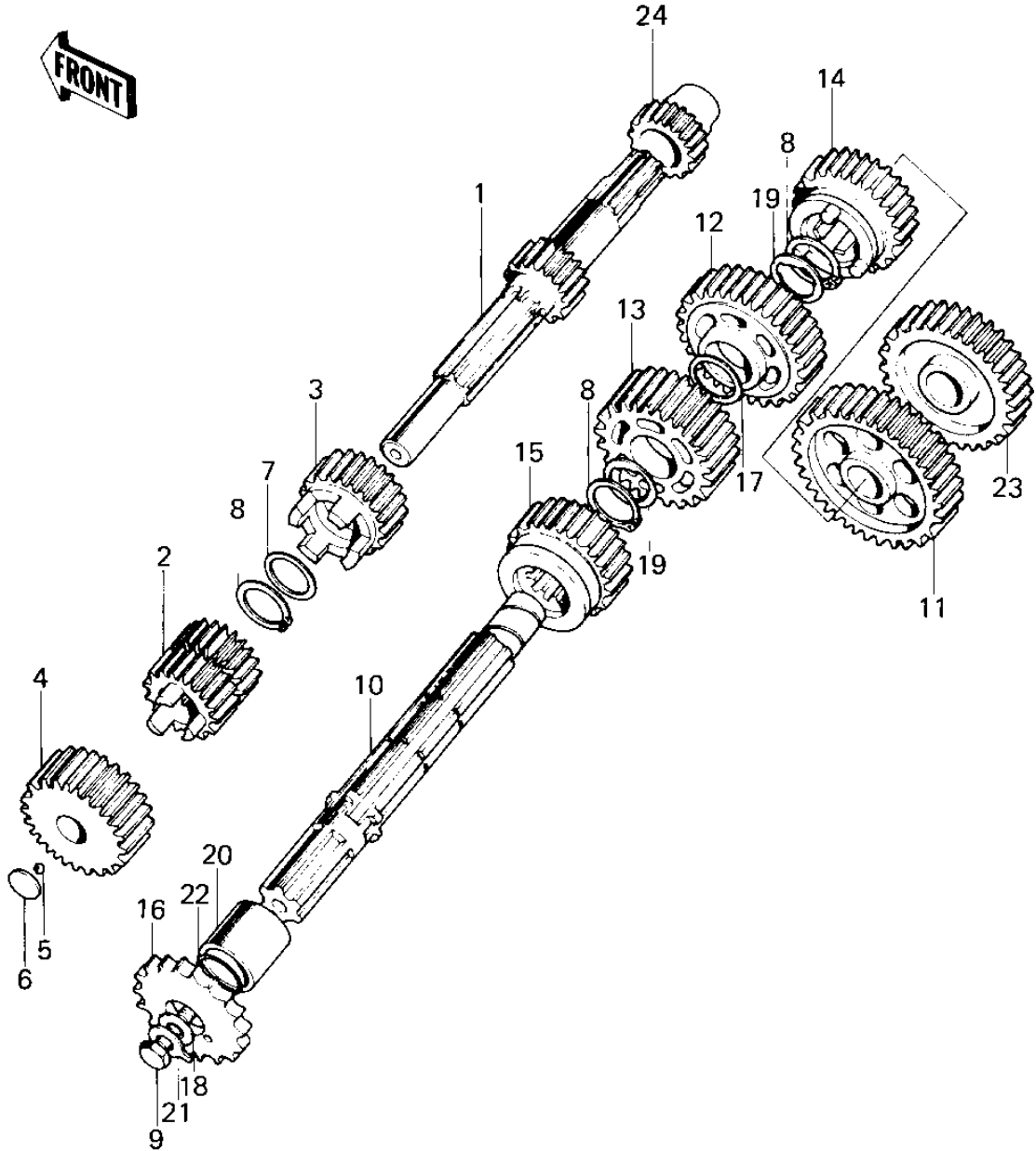

## 1978 KM100-A3 PARTS LIST

### TRANSMISSION (KM100-A6/A7)

ITEM NAME	PART NUMBER	QUANTITY
SHAFT,DRIVE (Ref # 1)	13127-1017	
2ND&3RD GEAR,DRIVE (Ref # 2)	13129-1052	
4TH GEAR,DRIVE (Ref # 3)	13129-1053	
GEAR,INPUT TOP,24T (Ref # 4)	13129-1927	
BALL STEEL 7/32' (Ref # 5)	600A0700	
WASHER THRUST (Ref # 6)	92022-115	
WASHER THRUST (Ref # 7)	92022-118	
CIRCLIP (Ref # 8)	92033-014	
BOLT-SMALL-UPSET,8X16 (Ref # 9)	115G0816	
BOLT,UPSET,8X16 (Ref # 9)	92001-1368	
SHAFT OUTPUT (Ref # 10)	13128-021	
LOW GEAR OUTPUT SHAFT (Ref # 11)	13129-010	
2ND GEAR OUTPUT SHAFT (Ref # 12)	13131-008	
3RD GEAR OUTPUT SHAFT (Ref # 13)	13133-005	
GEAR-TRANSMISSION SPU (Ref # 14)	13129-1708	
TOP GEAR OUTPUT SHAFT (Ref # 15)	13137-012	
SPROCKET-OUTPUT,14T (Ref # 16)	13144-1058	
ENGINE SPROCKET,13T (Ref # 16)	13144-053	
ENGINE SPROCKET,1ST (Ref # 16)	13144-054	
WASHER THRUST (Ref # 17)	92022-146	
WASHER,ENGINE SPRCKT (Ref # 18)	92022-266	
WASHER-LOCK (Ref # 19)	92024-030	
COLLAR,ENG SPROCKET (Ref # 20)	92027-1595	
WASHER,LOCK,8MM (Ref # 21)	92030-012	
"O" RING (Ref # 22)	92055-022	
IDLE GEAR (Ref # 23)	13073-004	
PINION KICKSTARTER (Ref # 24)	13075-004	