

1977 KE100 PARTS DIAGRAM

TAILLIGHT

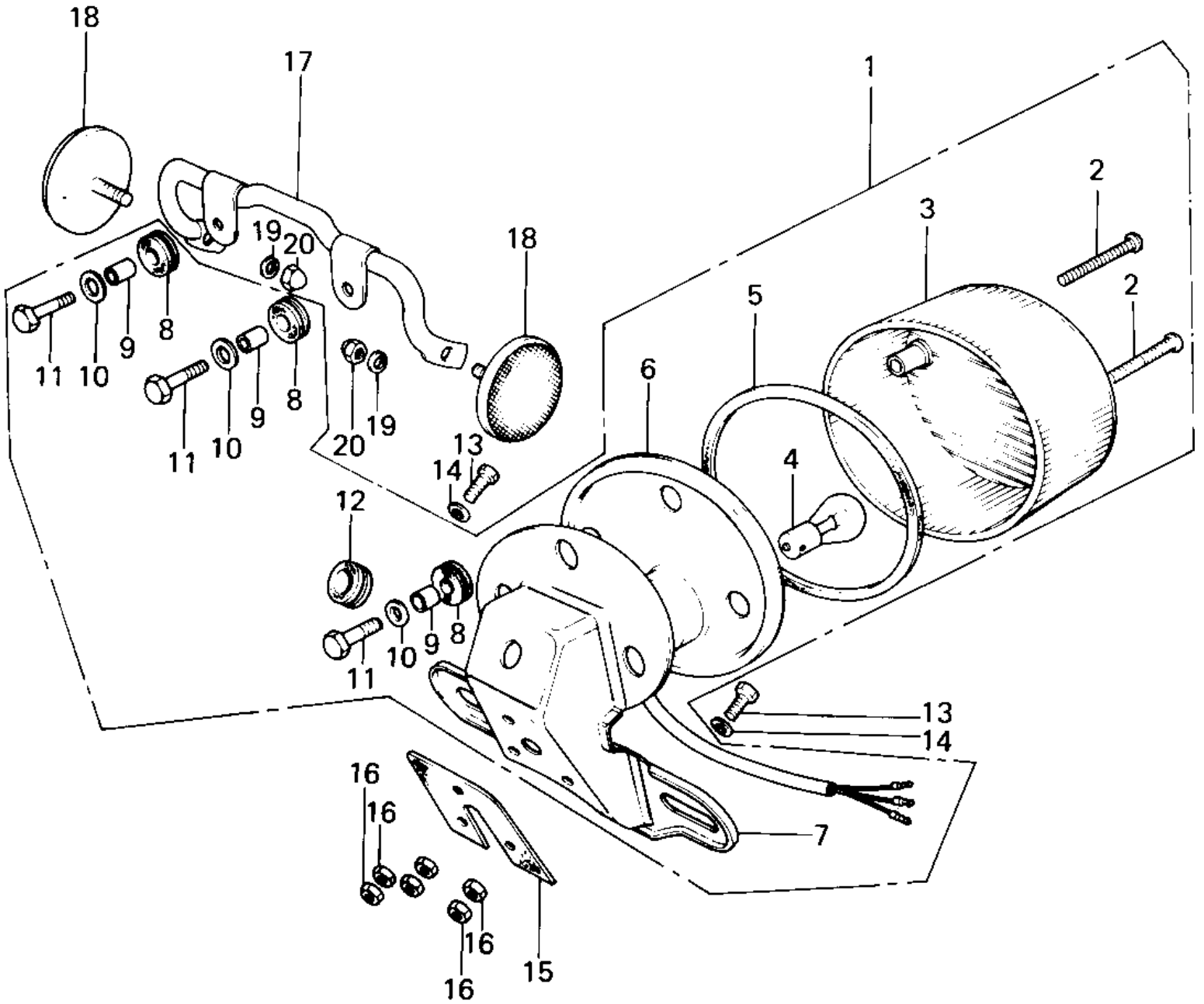

1977 KE100 PARTS LIST

TAILLIGHT

ITEM NAME	PART NUMBER	QUANTITY
LAMP ASSY, TAIL, BLACK (Ref # 1)	23024-069-21	
SCREW-PAN HEAD, 4X35 (Ref # 2)	220E0435A	
LENS-TAIL LAMP (Ref # 3)	23026-023	
BULB, 60-32/3CP (Ref # 4)	92069-074	
GASKET-TAIL LAMP LENS (Ref # 5)	23028-018	
CASE, TAIL LAMP (Ref # 6)	23027-030	
BKT-LICENSE PLT. BLACK (Ref # 7)	23036-019-21	
DAMPER RUBBER (Ref # 8)	92075-076	
COLLAR, 6.8X10X8.5 (Ref # 9)	92027-129	
WASHER 6.5X20X1.6T (Ref # 10)	92022-125	
BOLT 6X22 (Ref # 11)	112B0622	
GROMMET HARNESS 10MM (Ref # 12)	92071-019	
BOLT-UPSET (Ref # 13)	112G0630	
WASHER 6.5X20X1.6T (Ref # 14)	92022-125	
DAMPER-TAIL LAMP SHCK (Ref # 15)	35039-005	
NUT 6MM (Ref # 16)	311B0600	
BRACKET-REFLECTOR (Ref # 17)	28013-005	
REFLECTOR-REFLEX, REAR (Ref # 18)	28012-008	
WASHER SPRING 5MM (Ref # 19)	461F0500	
NUT-CAP, 5MM (Ref # 20)	322N0500	