

# 1977 KE100 PARTS DIAGRAM

## OIL PUMP

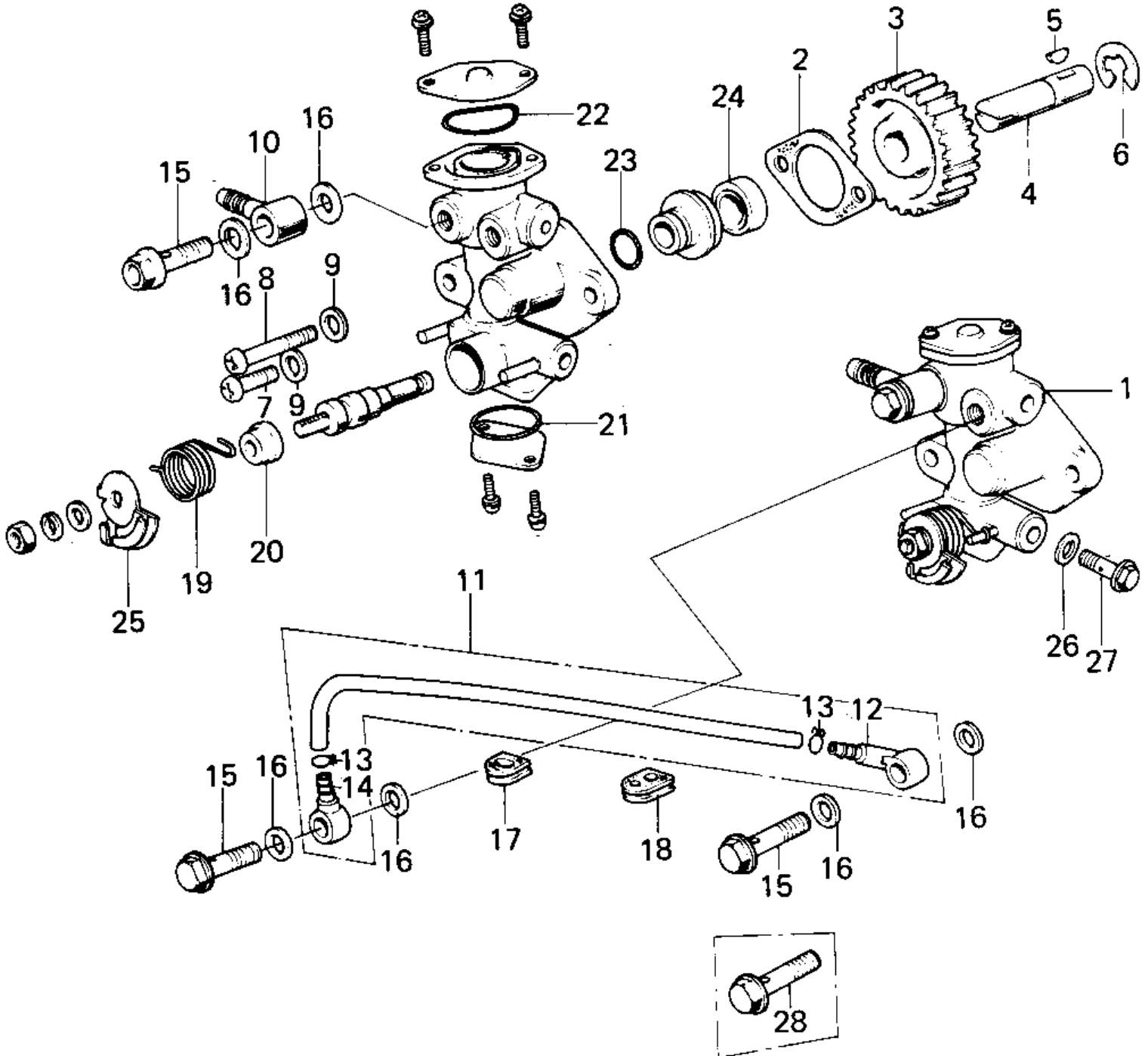

# 1977 KE100 PARTS LIST

## OIL PUMP

ITEM NAME	PART NUMBER	QUANTITY
PUMP ASSY, OIL (Ref # 1)	16082-067	
PUMP ASSY, OIL (Ref # 1)	16082-067	
GASKET,OIL PUMP (Ref # 2)	11060-1160	
GEAR OIL PUMP (Ref # 3)	16085-004	
SHAFT OIL PUMP (Ref # 4)	16086-001	
WOODRUFF KEY (Ref # 5)	510A3100	
CIRCLIP 9MM (Ref # 6)	482K9000	
SCREW-PAN-CROS (Ref # 7)	220B0514	
SCREW PAN CROSS,5X28 (Ref # 8)	220B0528	
WASHER OIL PUMP (Ref # 9)	92022-037	
CONNECTOR BANJO (Ref # 10)	92061-009	
PIPE,OIL (Ref # 11)	16134-021	
VALVE,CHECK (Ref # 12)	16128-009	
CLAMP,OIL PIPE (Ref # 13)	92036-022	
CONNECTOR,OIL PIPE (Ref # 14)	92061-018	
BOLT-BANJO,6MM (Ref # 15)	92060-013	
BOLT-BANJO,6MM (Ref # 15)	92060-013	
WASHER OIL PUMP BANJO (Ref # 16)	92022-077	
GROMMET WIRING HARN (Ref # 17)	21017-002	
GROMMET,OIL PIPE (Ref # 18)	92071-067	
SPRING,OIL PUMP LEVER (Ref # 19)	16093-006	
SEAL-OIL,CAMSHAFT,"X" (Ref # 20)	92049-1294	
"0" RING,LOWER CAP (Ref # 21)	16090-003	
"0" RING,LOWER CAP (Ref # 21)	16090-004	
"0" RING,UPPER CAP (Ref # 22)	16088-002	
"0" RING,OIL PUMP SHT (Ref # 23)	16090-002	
OIL SEAL OIL PUMP SHT (Ref # 24)	16091-001	
LEVER,OIL PUMP CABLE (Ref # 25)	16096-012	
WASHER (Ref # 26)	92022-1006	