

1977 KE100 PARTS DIAGRAM

GEAR CHANGE MECHANISM (KE100-A5/A6/A7/A8)

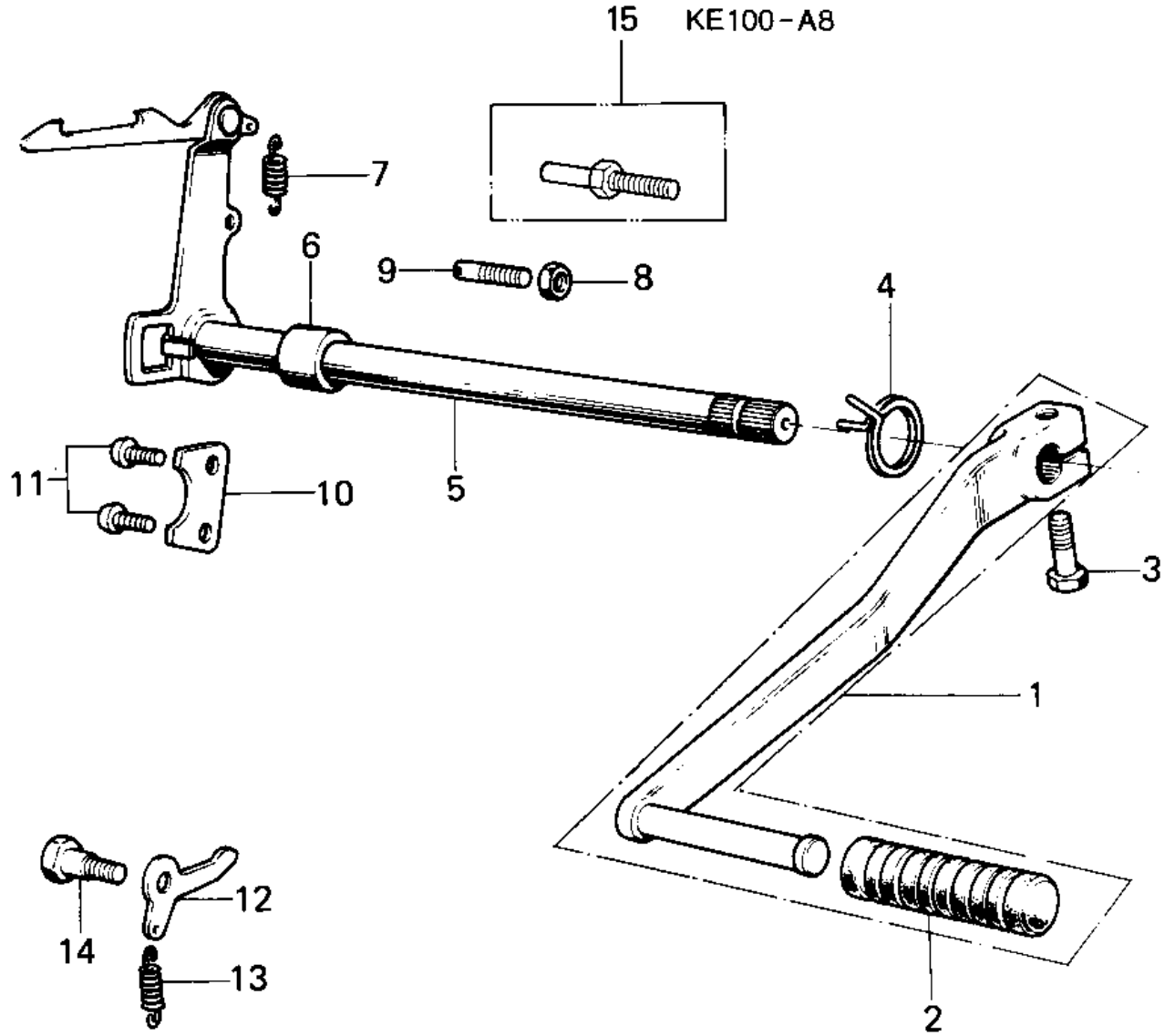

1977 KE100 PARTS LIST

GEAR CHANGE MECHANISM (KE100-A5/A6/A7/A8)

ITEM NAME	PART NUMBER	QUANTITY
PEDAL SET GEAR CHANGE (Ref # 1)	13242-004	
RUBBER CHANGE PEDAL (Ref # 2)	13157-004	
BOLT-UPSET,6X20 (Ref # 3)	112G0620	
SPRING,TENTION (Ref # 4)	92081-1129	
SPRING,TENTION (Ref # 4)	92081-1129	
LEVER ASSY,GEAR CHNG (Ref # 5)	13161-1014	
COLLAR (Ref # 6)	92027-121	
SPRING,CHNG DRUM LEV (Ref # 7)	92083-012	
SPRING,CHANGE LEVER (Ref # 7)	92144-1720	
NUT 8MM (Ref # 8)	312B0800	
BOLT,RETURN SPRING (Ref # 9)	92001-1401	
PIN CHANGE PEDAL SPRG (Ref # 9)	92043-057	
PLATE CHNG DRUM PSTN (Ref # 10)	13169-002	
SCREW PAN HEAD 6X14 (Ref # 11)	220B0614	
LEVER GEAR CHNG DRUM (Ref # 12)	13168-005	
SPRING,CHNG DRUM LEV (Ref # 13)	92083-012	
BOLT,CHANGE DRUM LEVE (Ref # 14)	92150-1450	
BOLT,RETURN SPRING (Ref # 15)	92001-1401	
BOLT,RETURN SPRING (Ref # 15)	92001-1401	