

## 1978 KD100-M3 PARTS DIAGRAM

FRONT HUB/BRAKE

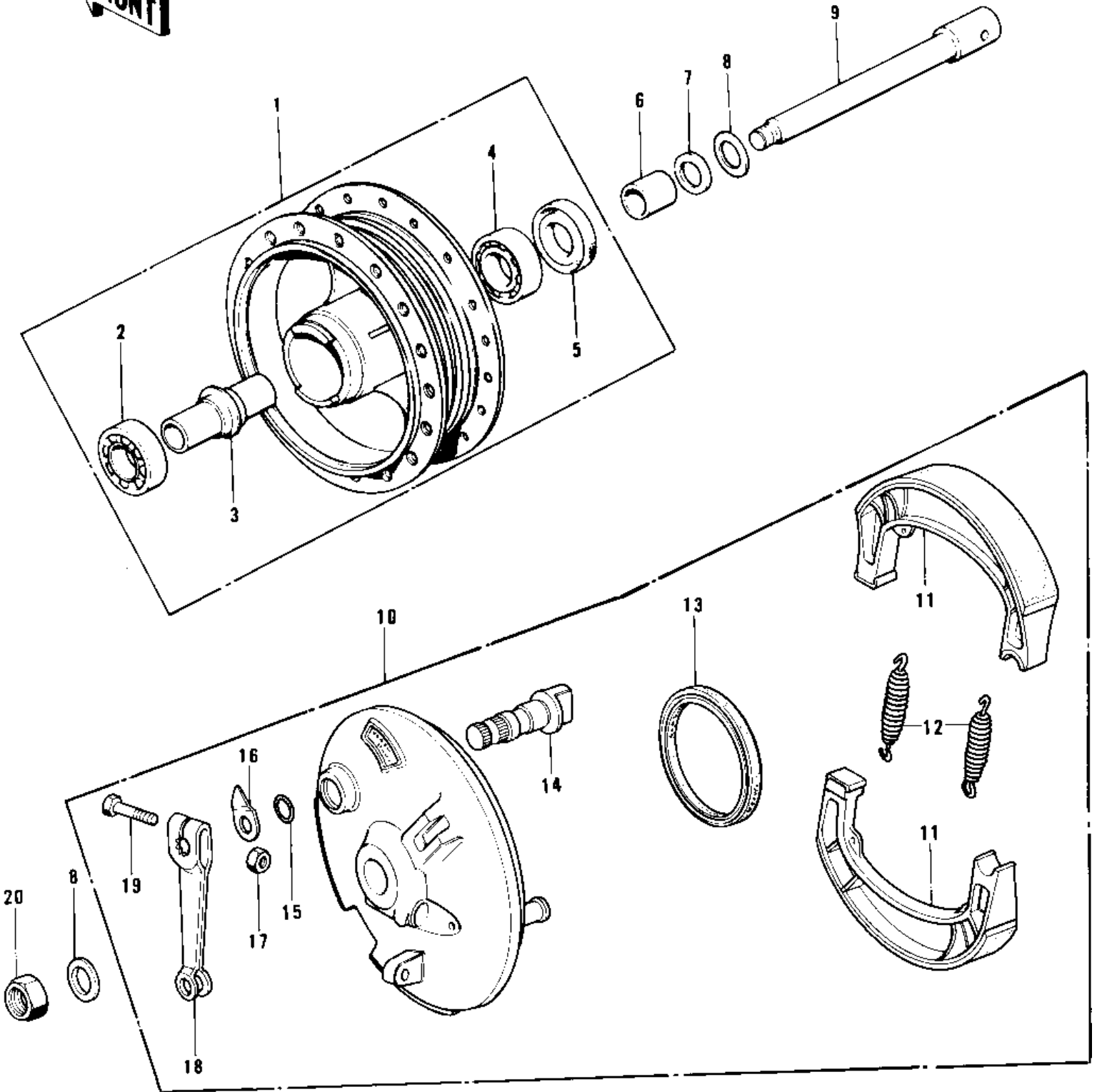

## 1978 KD100-M3 PARTS LIST

### FRONT HUB/BRAKE

ITEM NAME	PART NUMBER	QUANTITY
DRUM-ASSY,FR BRK (Ref # 1)	41034-1040	1
BEARING BALL #6300Z (Ref # 2)	601B6300Z	1
SPACER FRONT HUB (Ref # 3)	41039-002	1
BEARING BALL #6200 (Ref # 4)	601B6200	1
OIL SEAL,TC17317 (Ref # 5)	92050-063	1
COLLAR,FRONT AXLE (Ref # 6)	41069-026	1
DUST SHIELD FRNT DRUM (Ref # 7)	41042-002	1
WASHER PLAIN 10MM (Ref # 8)	411B1000	1
AXLE-FRONT (Ref # 9)	41068-039	1
PANEL-ASY,FR BRK BUFF (Ref # 10)	41035-069-80	1
SHOE-BRAKE (Ref # 11)	41048-1085	1
SPRING,BRAKE SHOE (Ref # 12)	92081-1766	1
OIL SEAL BRAKE PANEL (Ref # 13)	92050-002	1
CAM SHAFT-FRONT BRAKE (Ref # 14)	41050-018	1
"O" RING,11MM (Ref # 15)	92055-004	1
INDICATOR,FR BK SHOE (Ref # 16)	41085-013	1
NUT,6MM (Ref # 17)	41072-007	1
LEVER FRONT BRAKE CAM (Ref # 18)	41053-005	1
BOLT-UPSET (Ref # 19)	112G0630	1
NUT 10MM (Ref # 20)	42045-005	1