

1995 550 SX PARTS DIAGRAM

Hull

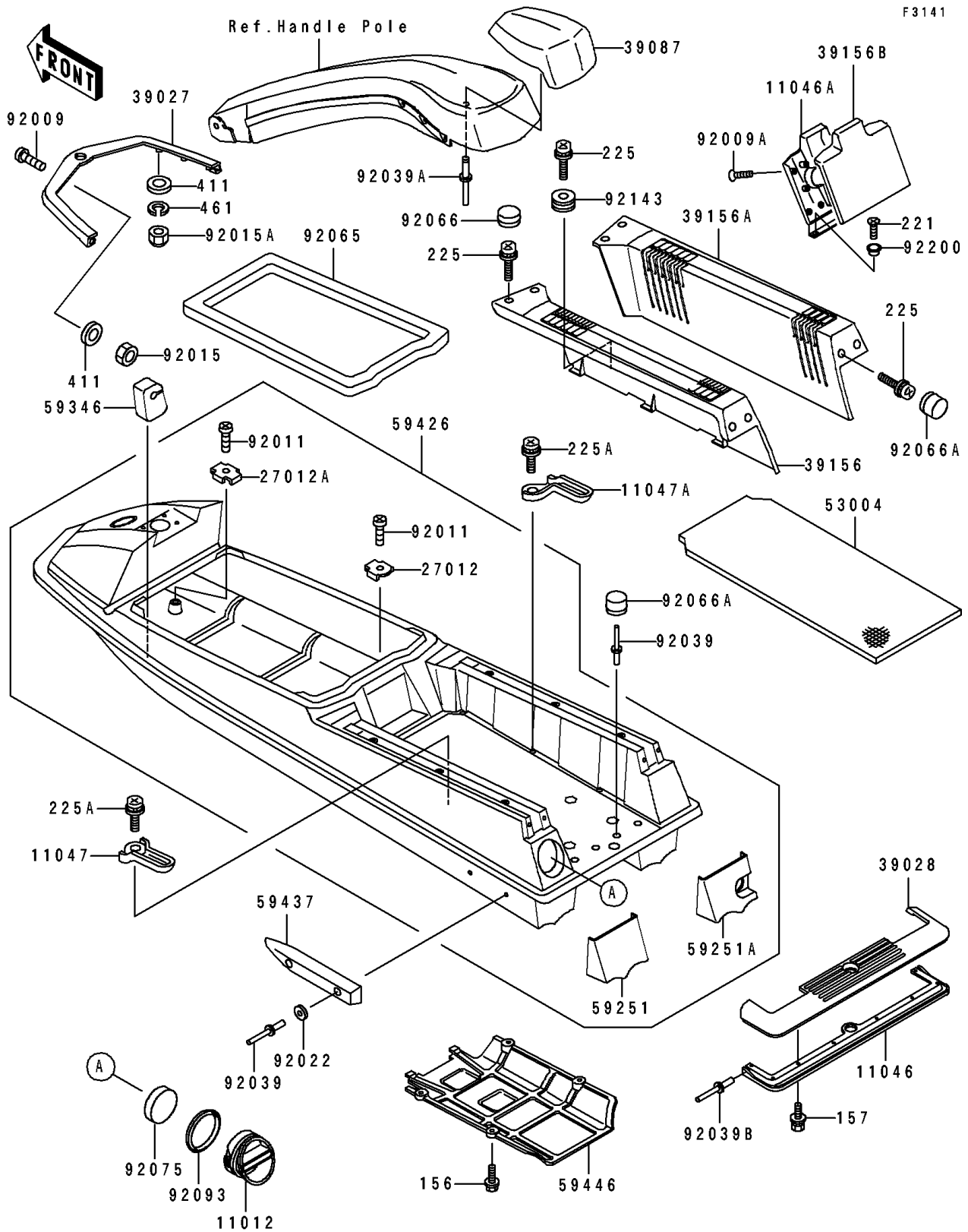

1995 550 SX PARTS LIST

Hull

ITEM NAME	PART NUMBER	QUANTITY
CAP,FIRE EXTINGUISHER (Ref # 11012)	11012-3741	1
BRACKET,REAR BUMPER (Ref # 11046)	11046-3829	1
BRACKET,CONTROL PANEL COVER (Ref # 11046A)	11046-3835	1
BRACKET,DECK,PAD,LH (Ref # 11047)	11047-3703	3
BRACKET,DECK,PAD,RH (Ref # 11047A)	11047-3704	3
HOOK (Ref # 27012)	27012-501	5
HOOK (Ref # 27012A)	27012-502	2
BUMPER-FRONT (Ref # 39027)	39027-3713	1
BUMPER-REAR (Ref # 39028)	39028-3705	1
PAD-HANDLE,POLE (Ref # 39087)	39087-3701	1
PAD,DECK,LH (Ref # 39156)	39156-3731	1
PAD,DECK,RH (Ref # 39156A)	39156-3732	1
PAD,CONTROL PANEL COVER (Ref # 39156B)	39156-3733	1
MAT,DECK (Ref # 53004)	53004-3731	1
HULL,LH,EXTENSION,JET WHITE (Ref # 59251)	59251-3006-8C	1
HULL,RH,EXTENSION,JET WHITE (Ref # 59251A)	59251-3713-8C	1
DETENT (Ref # 59346)	59346-504	3
HULL-COMP,JET WHITE (Ref # 59426)	59426-3777-8C	1
STABILIZER (Ref # 59437)	59437-3002	2
COVER-JET PUMP (Ref # 59446)	59446-3718	1
SCREW,5X22 (Ref # 92009)	92009-3761	6
SCREW,4X8 (Ref # 92009A)	92009-3770	10
SCREW,TAPPING (Ref # 92011)	92011-561	9
NUT,FLANGED,5MM (Ref # 92015)	92015-3768	6
NUT,CAP,5MM (Ref # 92015A)	92015-3802	6
WASHER,5X16X1.5 (Ref # 92022)	92022-3041	4
RIVET (Ref # 92039)	92039-3002	8
RIVET (Ref # 92039A)	92039-3712	6
RIVET (Ref # 92039B)	92039-3733	2

1995 550 SX PARTS LIST

Hull

ITEM NAME	PART NUMBER	QUANTITY
GASKET,ENGINE HOOD (Ref # 92065)	92065-539	1
PLUG (Ref # 92066)	92066-3731	4
PLUG (Ref # 92066A)	92066-3734	8
DAMPER (Ref # 92075)	92075-3719	1
SEAL,OSR70X82X7.5 (Ref # 92093)	92093-3704	1
COLLAR (Ref # 92143)	92143-3711	6
WASHER (Ref # 92200)	92200-3706	2
BOLT-WP,6X25 (Ref # 156)	156R0625	4
BOLT-WSP,5X20 (Ref # 157)	157R0520	8
SCREW-CSK-CROS,6X16 (Ref # 221)	221R0616	2
SCREW-PAN-WSP-CROS,6X16 (Ref # 225)	225R0616	14
SCREW-PAN-WSP-CROS,6X20 (Ref # 225A)	225R0620	6
WASHER-PLAIN,5MM (Ref # 411)	411S0500	12
WASHER-SPRING,5MM (Ref # 461)	461S0500	6