

1995 550 SX PARTS DIAGRAM

Muffler(s)

E1140

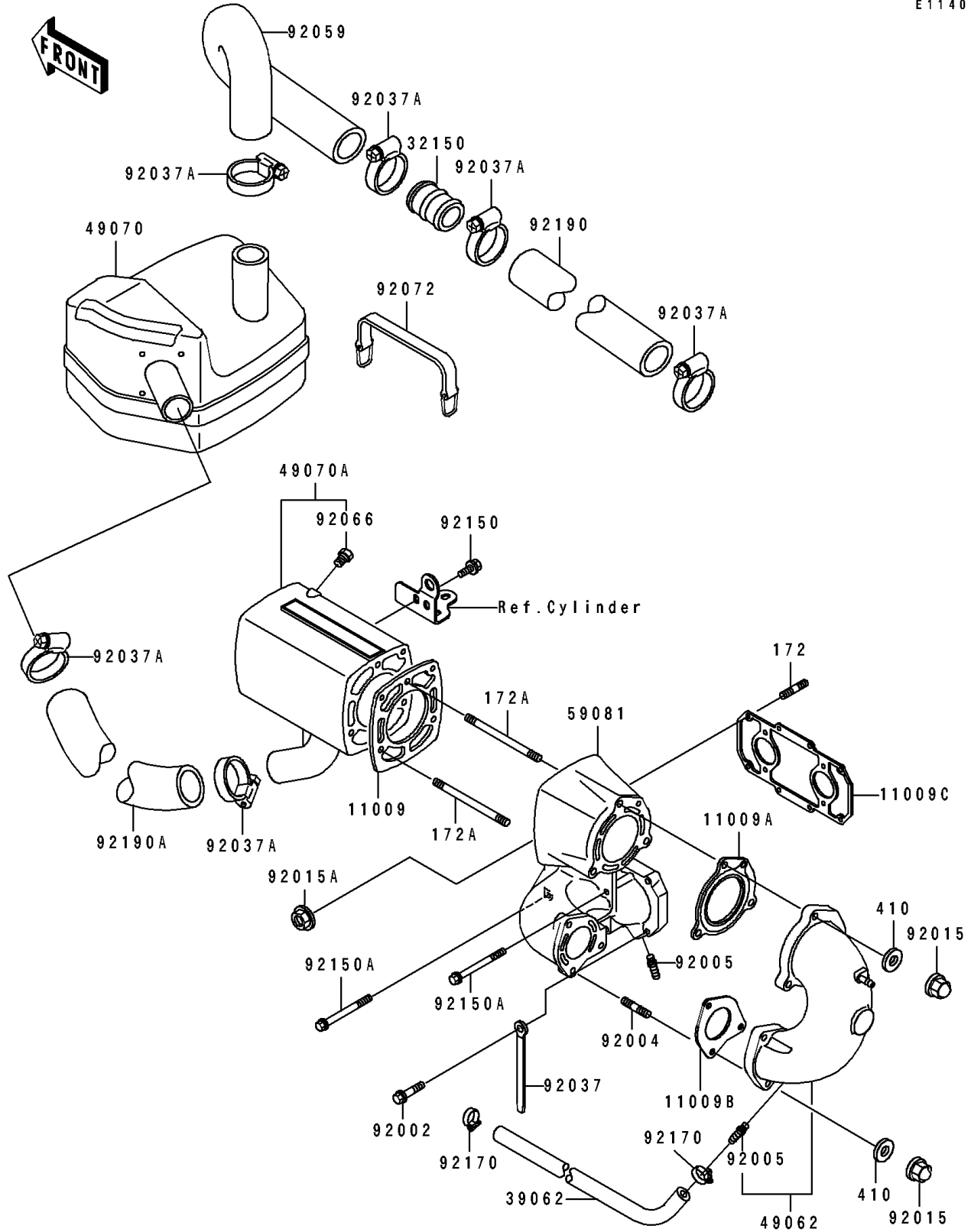

1995 550 SX PARTS LIST

Muffler(s)

ITEM NAME	PART NUMBER	QUANTITY
GASKET,MUFFLER (Ref # 11009)	11009-3776	1
GASKET,EXHAUST PIPE (Ref # 11009A)	11009-3777	1
GASKET,EXHAUST PIPE (Ref # 11009B)	11009-3778	1
GASKET,EXHAUST MANIFOLD (Ref # 11009C)	11009-3779	1
PIPE (Ref # 32150)	32150-3784	1
HOSE-COOLING (Ref # 39062)	39062-3701	1
PIPE-COMP-EXHAUST (Ref # 49062)	49062-3704	1
MUFFLER-COMP,WATER BOX (Ref # 49070)	49070-3702	1
MUFFLER-COMP (Ref # 49070A)	49070-3715	1
MANIFOLD-EXHAUST (Ref # 59081)	59081-3707	1
BOLT,6X30 (Ref # 92002)	92002-3726	5
STUD,8X27.5 (Ref # 92004)	92004-3022	3
FITTING,HOSE (Ref # 92005)	92005-3712	2
NUT,CAP,8MM (Ref # 92015)	92015-1371	6
NUT,6MM (Ref # 92015A)	92015-3767	2
CLAMP,L=100 (Ref # 92037)	92037-3736	1
CLAMP (Ref # 92037A)	92037-509	6
TUBE,EXHAUST (Ref # 92059)	92059-3722	1
PLUG,CYLINDER HEAD (Ref # 92066)	92066-3001	1
BAND (Ref # 92072)	92072-511	2
BOLT,8X16 (Ref # 92150)	92150-3722	2
BOLT,6X73 (Ref # 92150A)	92150-3776	5
CLAMP (Ref # 92170)	92170-3729	2
TUBE,L=860 (Ref # 92190)	92190-3718	1
TUBE,39X51X455 (Ref # 92190A)	92190-3921	1
BOLT-STUD (Ref # 172)	172R0625	2
BOLT-STUD,8X120 (Ref # 172A)	172R08120	3
WASHER-PLAIN-SMALL,8MM (Ref # 410)	410S0800	6